

PDF technical sheet 24126EAW33C4



Double row spherical roller bearings

Spherical roller bearing, with central rib on inner ring, pressed steel cage, groove and lubrication holes on outer ring

Product definition	
d	5.1181 "
D	8.2677 "
B	3.1496 "
d2	5.6929 "
D1	7.2480 "
rs min	0.0787 "
Number of lubrication holes	3
b	0.3740 "
k	0.1772 "
e	0.35
Y1	1.92
Y2	2.86
Y0	1.88
Radial clearance class	C4
Mass	41.62 oz
Brand	SNR

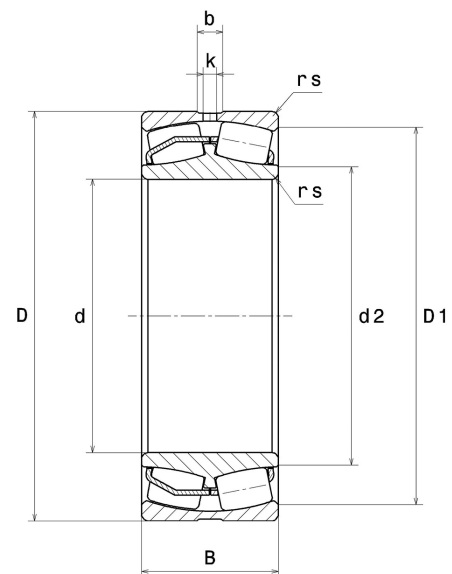

Product performance	
Dynamic load, C	754 kN
Static load, C0	964 kN
Fatigue limit load, Cu	66.60 kN
Nref	1,900 RPM
Nlim	2,400 RPM
Min operating temperature, Tmin	-40 °C
Max operating temperature, Tmax	392 °C
Characteristic cage frequency, FTF	0.44 Hz
Characteristic rolling element frequency, BSF	7.61 Hz
Characteristic outer ring frequency, BPF0	9.18 Hz
Characteristic inner ring frequency, BPF1	11.82 Hz

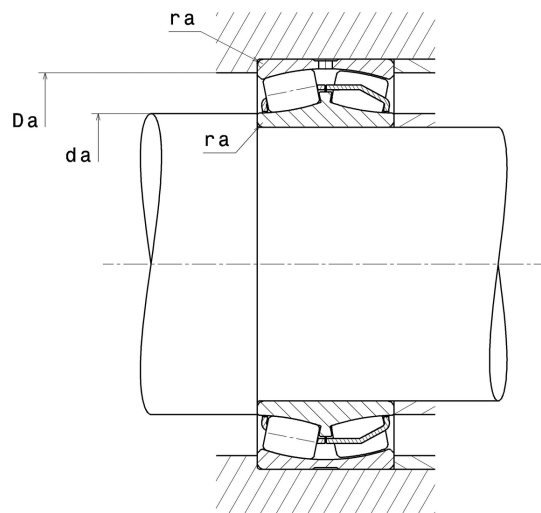

Abutment dimensions

da min	5.5512 "
Da max	7.8346 "
ra max	0.0787 "

Calculation factors

Equivalent dynamic radial load

$$P = X.F_r + Y.F_a$$

Fa / Fr ≤ e		Fa / Fr > e	
X	Y	X	Y
1	Y1	0.67	Y2

Equivalent static radial load

$$P_0 = X_0.F_r + Y_0.F_a$$

X ₀	Y ₀
1	Y0

The values for e, Y1, Y2 and Y0 are shown in the above table .