

PDF technical sheet 24048EMW33



Double row spherical roller bearings

Spherical roller bearing, one-piece machined cage, groove and lubrication holes on outer ring

Product definition	
d	9.4488 "
D	14.1732 "
B	4.6457 "
D1	12.7165 "
rs min	0.1181 "
Number of lubrication holes	3
b	0.6024 "
k	0.2756 "
e	0.29
Y1	2.32
Y2	3.45
Y0	2.26
Radial clearance class	CN
Mass	146.74 oz
Brand	SNR

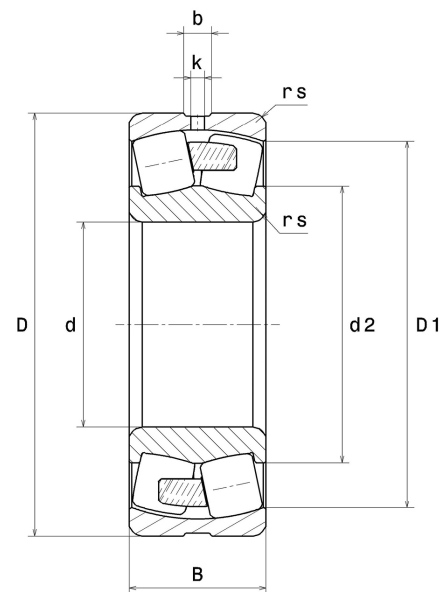

Product performance	
Dynamic load, C	2,020 kN
Static load, C0	3,050 kN
Fatigue limit load, Cu	172 kN
Nref	1,100 RPM
Nlim	1,700 RPM
Min operating temperature, Tmin	-40 °C
Max operating temperature, Tmax	392 °C
Characteristic cage frequency, FTF	0.45 Hz
Characteristic rolling element frequency, BSF	8.80 Hz
Characteristic outer ring frequency, BPF0	11.12 Hz
Characteristic inner ring frequency, BPF1	13.88 Hz

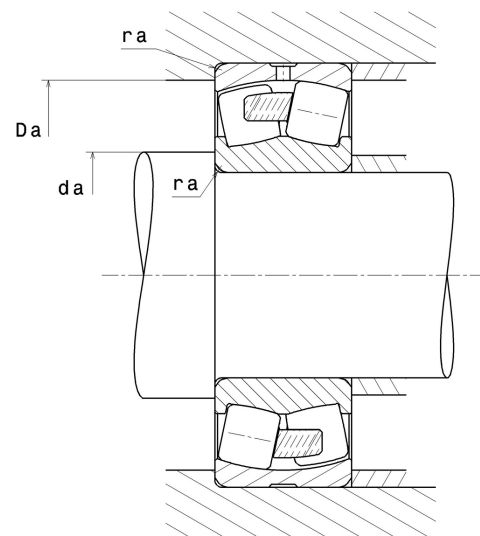

Abutment dimensions

da min	9.9370 "
Da max	13.6850 "
ra max	0.0984 "

Calculation factors

Equivalent dynamic radial load

$$P = X.F_r + Y.F_a$$

Fa / Fr ≤ e		Fa / Fr > e	
X	Y	X	Y
1	Y1	0.67	Y2

Equivalent static radial load

$$P_0 = X_0.F_r + Y_0.F_a$$

X ₀	Y ₀
1	Y0

The values for e, Y1, Y2 and Y0 are shown in the above table .