

## PDF technical sheet 24036EAW33C3



### Double row spherical roller bearings

Spherical roller bearing, pressed steel cage, groove and lubrication holes on outer ring

Product definition	
d	7.0866 "
D	11.0236 "
B	3.9370 "
d2	7.9685 "
D1	9.8031 "
rs min	0.0827 "
Number of lubrication holes	3
b	0.4646 "
k	0.1969 "
e	0.31
Y1	2.21
Y2	3.29
Y0	2.16
Radial clearance class	C3
Mass	80.78 oz
Brand	SNR



Product performance	
Dynamic load, C	1,270 kN
Static load, C0	1,830 kN
Fatigue limit load, Cu	109 kN
Nref	1,500 RPM
Nlim	2,200 RPM
Min operating temperature, Tmin	-40 °C
Max operating temperature, Tmax	392 °C
Characteristic cage frequency, FTF	0.44 Hz
Characteristic rolling element frequency, BSF	8.59 Hz
Characteristic outer ring frequency, BPF0	10.65 Hz
Characteristic inner ring frequency, BPF1	13.35 Hz

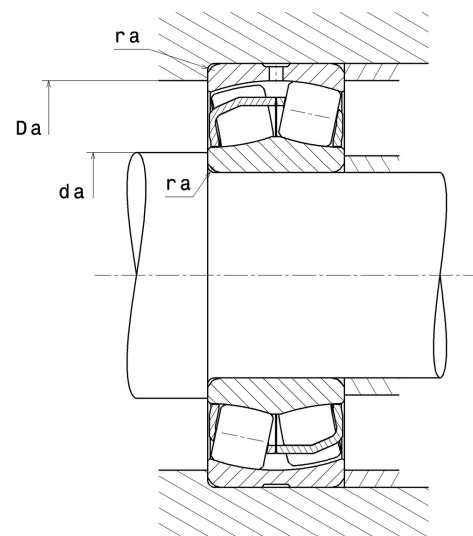

### Abutment dimensions

da min	7.4882 "
Da max	10.6220 "
ra max	0.0787 "

### Calculation factors

#### Equivalent dynamic radial load

$$P = X.F_r + Y.F_a$$

Fa / Fr ≤ e		Fa / Fr > e	
X	Y	X	Y
1	Y1	0.67	Y2

#### Equivalent static radial load

$$P_0 = X_0.F_r + Y_0.F_a$$

X <sub>0</sub>	Y <sub>0</sub>
1	Y0

The values for e, Y1, Y2 and Y0 are shown in the above table .