

PDF technical sheet 24034EAW33C3



Double row spherical roller bearings

Spherical roller bearing, pressed steel cage, groove and lubrication holes on outer ring

Product definition	
d	6.6929 "
D	10.2362 "
B	3.5433 "
d2	7.4016 "
D1	9.1457 "
rs min	0.0827 "
Number of lubrication holes	3
b	0.4201 "
k	0.1969 "
e	0.31
Y1	2.21
Y2	3.29
Y0	2.16
Radial clearance class	C3
Mass	59.01 oz
Brand	SNR



Product performance	
Dynamic load, C	1,120 kN
Static load, C0	1,580 kN
Fatigue limit load, Cu	97.40 kN
Nref	1,600 RPM
Nlim	2,400 RPM
Min operating temperature, Tmin	-40 °C
Max operating temperature, Tmax	392 °C
Characteristic cage frequency, FTF	0.44 Hz
Characteristic rolling element frequency, BSF	8.60 Hz
Characteristic outer ring frequency, BPF0	10.65 Hz
Characteristic inner ring frequency, BPF1	13.35 Hz

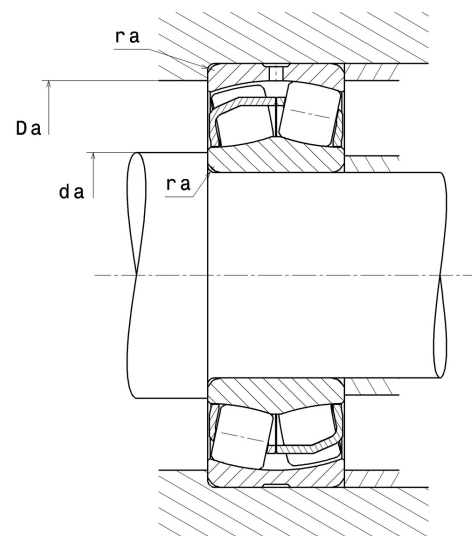

Abutment dimensions

da min	7.0945 "
Da max	9.8346 "
ra max	0.0787 "

Calculation factors

Equivalent dynamic radial load

$$P = X.F_r + Y.F_a$$

Fa / Fr ≤ e		Fa / Fr > e	
X	Y	X	Y
1	Y1	0.67	Y2

Equivalent static radial load

$$P_0 = X_0.F_r + Y_0.F_a$$

X ₀	Y ₀
1	Y0

The values for e, Y1, Y2 and Y0 are shown in the above table .