

PDF technical sheet 24024EAC4



Double row spherical roller bearings

Spherical roller bearing, pressed steel cage

Product definition

d	4.7244 "
D	7.0866 "
B	2.3622 "
d2	5.1417 "
D1	6.3858 "
rs min	0.0787 "
Number of lubrication holes	
e	0.3
Y1	2.28
Y2	3.39
Y0	2.23
Radial clearance class	C4
Mass	17.99 oz
Brand	SNR

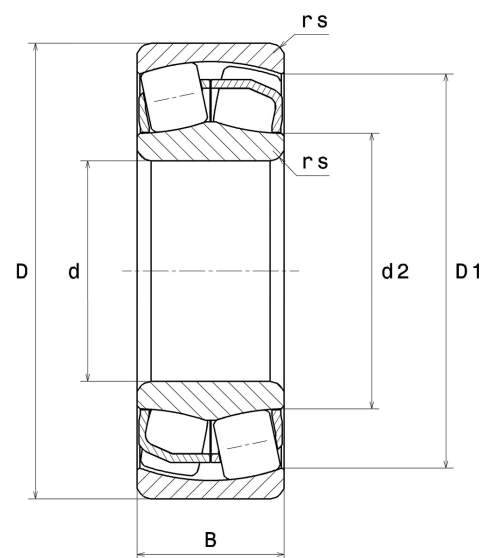

Product performance

Dynamic load, C	535 kN
Static load, C0	705 kN
Fatigue limit load, Cu	50.80 kN
Nref	2,500 RPM
Nlim	3,400 RPM
Min operating temperature, Tmin	-40 °C
Max operating temperature, Tmax	392 °C
Characteristic cage frequency, FTF	0.44 Hz
Characteristic rolling element frequency, BSF	8.57 Hz
Characteristic outer ring frequency, BPF0	10.20 Hz
Characteristic inner ring frequency, BPF1	12.80 Hz

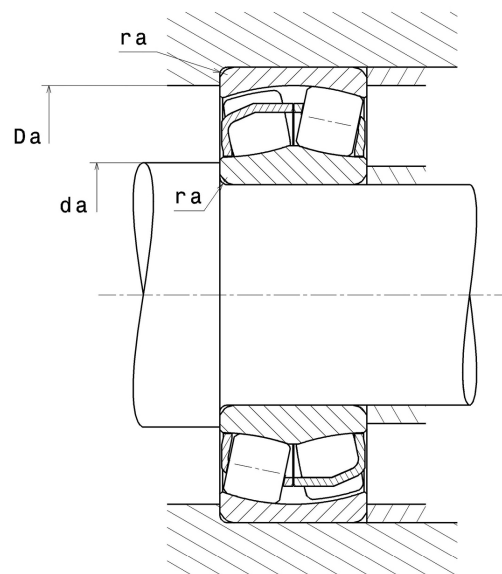

Abutment dimensions

da min	5.0709 "
Da max	6.7402 "
ra max	0.0787 "

Calculation factors

Equivalent dynamic radial load

$$P = X.F_r + Y.F_a$$

Fa / Fr ≤ e		Fa / Fr > e	
X	Y	X	Y
1	Y1	0.67	Y2

Equivalent static radial load

$$P_0 = X_0.F_r + Y_0.F_a$$

X ₀	Y ₀
1	Y0

The values for e, Y1, Y2 and Y0 are shown in the above table .