

PDF technical sheet 24022EMW33C4



Double row spherical roller bearings

Spherical roller bearing, one-piece machined cage, groove and lubrication holes on outer ring

Product definition	
d	4.3307 "
D	6.6929 "
B	2.3622 "
D1	5.9685 "
rs min	0.0787 "
Number of lubrication holes	3
b	0.2839 "
k	0.1181 "
e	0.31
Y1	2.15
Y2	3.2
Y0	2.1
Radial clearance class	C4
Mass	16.93 oz
Brand	SNR

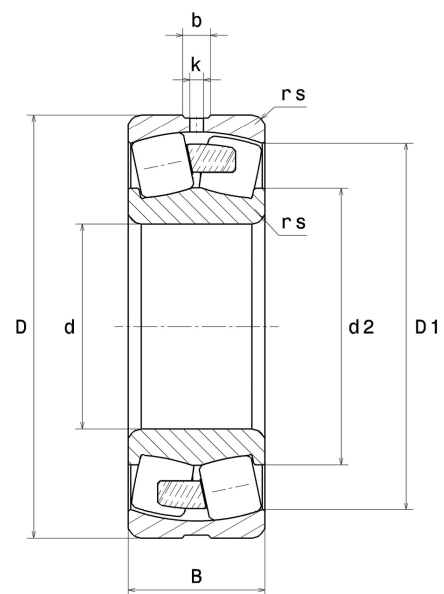

Product performance	
Dynamic load, C	518 kN
Static load, C0	663 kN
Fatigue limit load, Cu	46.70 kN
Nref	2,800 RPM
Nlim	3,700 RPM
Min operating temperature, Tmin	-40 °C
Max operating temperature, Tmax	392 °C
Characteristic cage frequency, FTF	0.44 Hz
Characteristic rolling element frequency, BSF	8.04 Hz
Characteristic outer ring frequency, BPF0	9.68 Hz
Characteristic inner ring frequency, BPF1	12.32 Hz

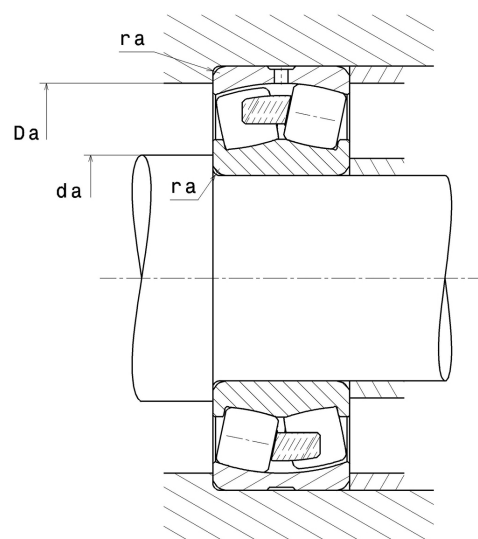

Abutment dimensions

da min	4.6772 "
Da max	6.3465 "
ra max	0.0787 "

Calculation factors

Equivalent dynamic radial load

$$P = X.F_r + Y.F_a$$

Fa / Fr ≤ e		Fa / Fr > e	
X	Y	X	Y
1	Y1	0.67	Y2

Equivalent static radial load

$$P_0 = X_0.F_r + Y_0.F_a$$

X ₀	Y ₀
1	Y0

The values for e, Y1, Y2 and Y0 are shown in the above table .