

## PDF technical sheet 23152EMW33



### Double row spherical roller bearings

Spherical roller bearing, one-piece machined cage, groove and lubrication holes on outer ring

Product definition	
d	10.2362 "
D	17.3228 "
B	5.6693 "
d2	12.7126 "
D1	15.3110 "
rs min	0.1575 "
Number of lubrication holes	8
b	0.7933 "
k	0.4724 "
e	0.3
Y1	2.25
Y2	3.34
Y0	2.2
Radial clearance class	CN
Mass	321.70 oz
Brand	SNR

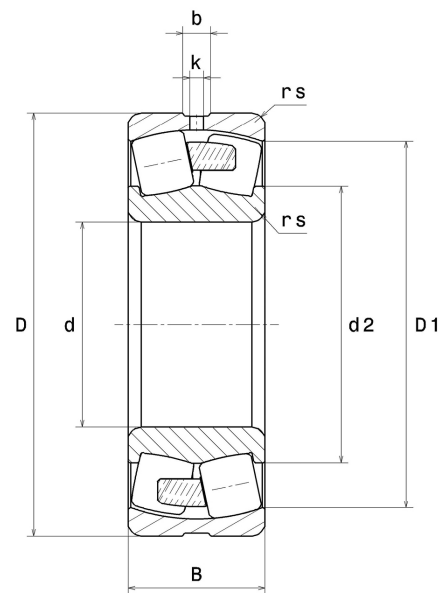

Product performance	
Dynamic load, C	2,930 kN
Static load, C0	4,340 kN
Fatigue limit load, Cu	239 kN
Nref	950 RPM
Nlim	1,400 RPM
Min operating temperature, Tmin	-40 °C
Max operating temperature, Tmax	392 °C
Characteristic cage frequency, FTF	0.44 Hz
Characteristic rolling element frequency, BSF	8.13 Hz
Characteristic outer ring frequency, BPF0	10.13 Hz
Characteristic inner ring frequency, BPF1	12.87 Hz

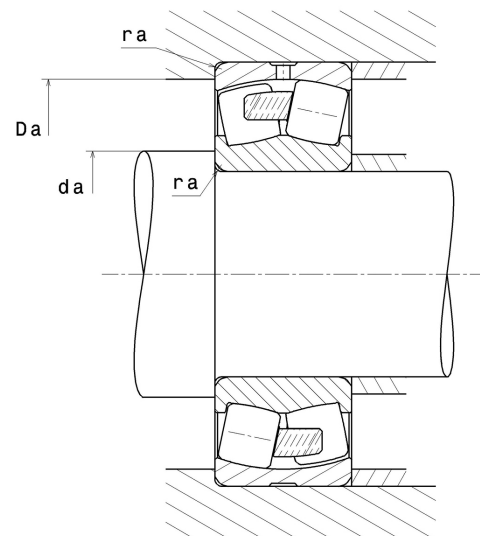

### Abutment dimensions

da min	10.9055 "
Da max	16.6535 "
ra max	0.1181 "

### Calculation factors

#### Equivalent dynamic radial load

$$P = X.F_r + Y.F_a$$

Fa / Fr ≤ e		Fa / Fr > e	
X	Y	X	Y
1	Y1	0.67	Y2

#### Equivalent static radial load

$$P_0 = X_0.F_r + Y_0.F_a$$

X <sub>0</sub>	Y <sub>0</sub>
1	Y0

The values for e, Y1, Y2 and Y0 are shown in the above table .