

## PDF technical sheet 23134EMW33C4



### Double row spherical roller bearings

Spherical roller bearing, one-piece machined cage, groove and lubrication holes on outer ring

Product definition	
d	6.6929 "
D	11.0236 "
B	3.4646 "
D1	9.8307 "
rs min	0.0827 "
Number of lubrication holes	3
b	0.5394 "
k	0.2362 "
e	0.28
Y1	2.39
Y2	3.56
Y0	2.34
Radial clearance class	C4
Mass	76.02 oz
Brand	SNR

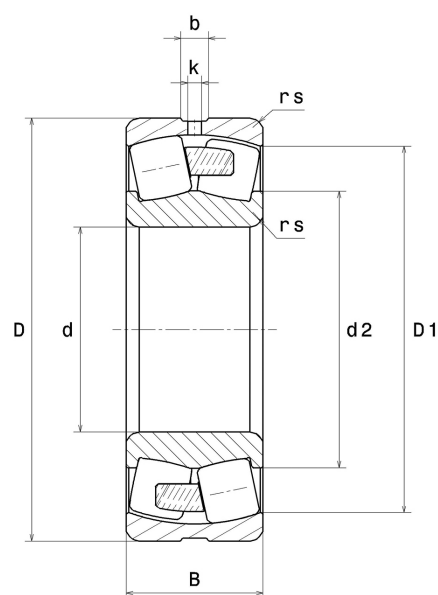

Product performance	
Dynamic load, C	1,270 kN
Static load, C0	1,700 kN
Fatigue limit load, Cu	112 kN
Nref	1,700 RPM
Nlim	2,300 RPM
Min operating temperature, Tmin	-40 °C
Max operating temperature, Tmax	392 °C
Characteristic cage frequency, FTF	0.44 Hz
Characteristic rolling element frequency, BSF	7.74 Hz
Characteristic outer ring frequency, BPF0	9.63 Hz
Characteristic inner ring frequency, BPF1	12.38 Hz

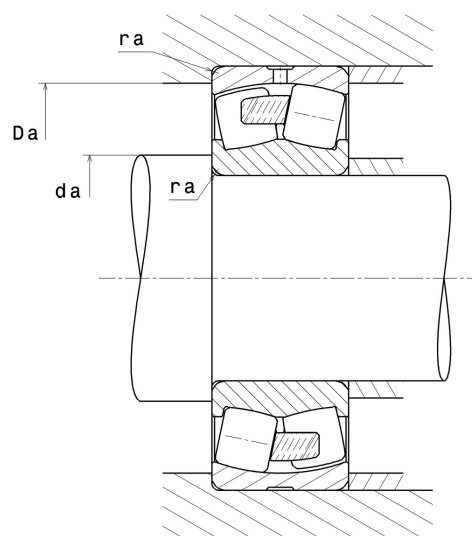

### Abutment dimensions

da min	7.1654 "
Da max	10.5512 "
ra max	0.0787 "

### Calculation factors

#### Equivalent dynamic radial load

$$P = X.F_r + Y.F_a$$

Fa / Fr ≤ e		Fa / Fr > e	
X	Y	X	Y
1	Y1	0.67	Y2

#### Equivalent static radial load

$$P_0 = X_0.F_r + Y_0.F_a$$

X <sub>0</sub>	Y <sub>0</sub>
1	Y0

The values for e, Y1, Y2 and Y0 are shown in the above table .