

## PDF technical sheet 23124EMW33C4



### Double row spherical roller bearings

Spherical roller bearing, one-piece machined cage, groove and lubrication holes on outer ring

Product definition	
d	4.7244 "
D	7.8740 "
B	2.4409 "
D1	7.0236 "
rs min	0.0787 "
Number of lubrication holes	3
b	0.3937 "
k	0.1772 "
e	0.28
Y1	2.43
Y2	3.61
Y0	2.37
Radial clearance class	C4
Mass	27.37 oz
Brand	SNR

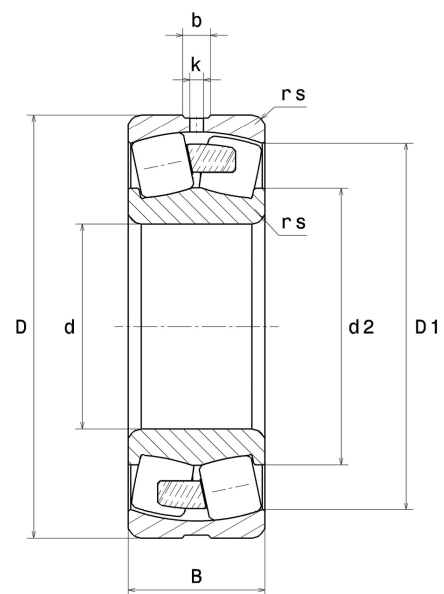

Product performance	
Dynamic load, C	663 kN
Static load, C0	820 kN
Fatigue limit load, Cu	62.30 kN
Nref	2,600 RPM
Nlim	3,200 RPM
Min operating temperature, Tmin	-40 °C
Max operating temperature, Tmax	392 °C
Characteristic cage frequency, FTF	0.44 Hz
Characteristic rolling element frequency, BSF	7.47 Hz
Characteristic outer ring frequency, BPF0	9.14 Hz
Characteristic inner ring frequency, BPF1	11.86 Hz

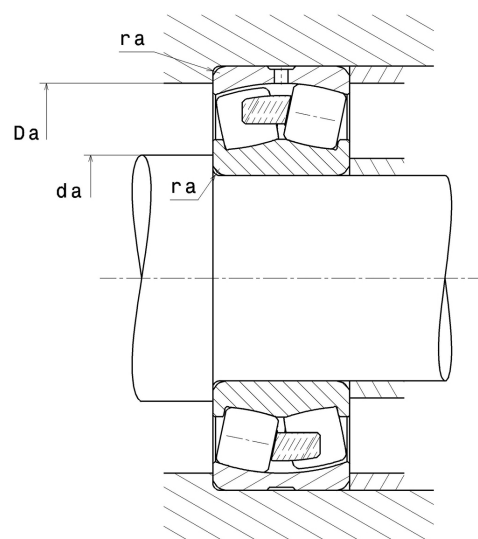

### Abutment dimensions

da min	5.1575 "
Da max	7.4409 "
ra max	0.0787 "

### Calculation factors

#### Equivalent dynamic radial load

$$P = X.F_r + Y.F_a$$

Fa / Fr ≤ e		Fa / Fr > e	
X	Y	X	Y
1	Y1	0.67	Y2

#### Equivalent static radial load

$$P_0 = X_0.F_r + Y_0.F_a$$

X <sub>0</sub>	Y <sub>0</sub>
1	Y0

The values for e, Y1, Y2 and Y0 are shown in the above table .