

PDF technical sheet 23038EMW33



Double row spherical roller bearings

Spherical roller bearing, one-piece machined cage, groove and lubrication holes on outer ring

Product definition	
d	7.4803 "
D	11.4173 "
B	2.9528 "
D1	10.4370 "
rs min	0.0827 "
Number of lubrication holes	3
b	0.5197 "
k	0.2362 "
e	0.22
Y1	3.01
Y2	4.48
Y0	2.94
Radial clearance class	CN
Mass	63.39 oz
Brand	SNR

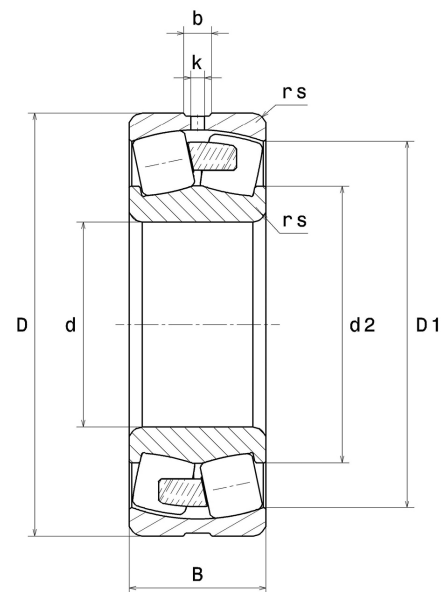

Product performance	
Dynamic load, C	1,140 kN
Static load, C0	1,570 kN
Fatigue limit load, Cu	120 kN
Nref	1,900 RPM
Nlim	2,400 RPM
Min operating temperature, Tmin	-40 °C
Max operating temperature, Tmax	392 °C
Characteristic cage frequency, FTF	0.44 Hz
Characteristic rolling element frequency, BSF	8.75 Hz
Characteristic outer ring frequency, BPF0	11.11 Hz
Characteristic inner ring frequency, BPF1	13.90 Hz

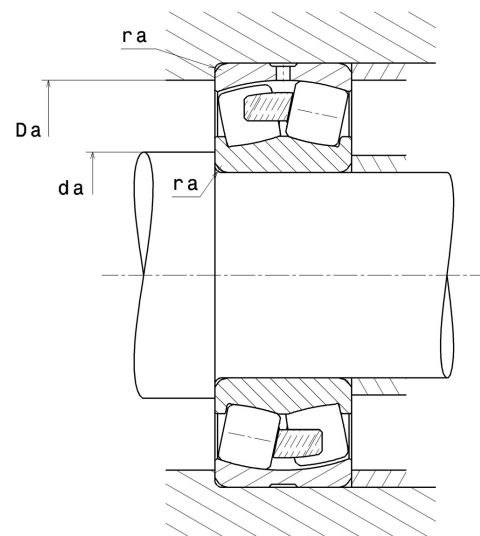

Abutment dimensions

da min	7.8819 "
Da max	11.0157 "
ra max	0.0787 "

Calculation factors

Equivalent dynamic radial load

$$P = X.F_r + Y.F_a$$

Fa / Fr ≤ e		Fa / Fr > e	
X	Y	X	Y
1	Y1	0.67	Y2

Equivalent static radial load

$$P_0 = X_0.F_r + Y_0.F_a$$

X ₀	Y ₀
1	Y0

The values for e, Y1, Y2 and Y0 are shown in the above table .