

PDF technical sheet 22326EMW33C3



Double row spherical roller bearings

Spherical roller bearing, one-piece machined cage, groove and lubrication holes on outer ring

Product definition	
d	5.1181 "
D	11.0236 "
B	3.6614 "
d2	6.4843 "
D1	9.5669 "
rs min	0.1575 "
Number of lubrication holes	3
b	0.7441 "
k	0.3543 "
e	0.33
Y1	2.06
Y2	3.06
Y0	2.01
Radial clearance class	C3
Mass	98.41 oz
Brand	SNR

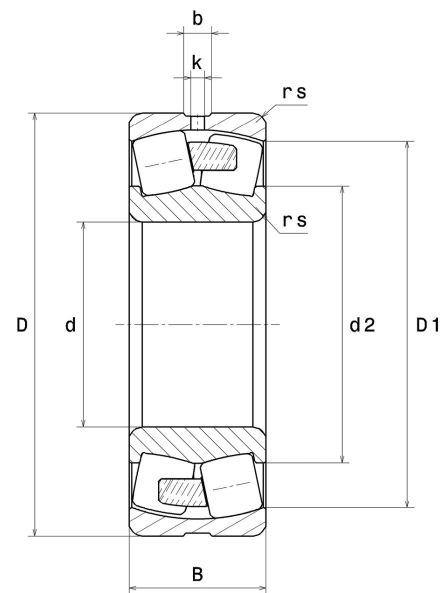

Product performance	
Dynamic load, C	1,330 kN
Static load, C0	1,400 kN
Fatigue limit load, Cu	113 kN
Nref	1,800 RPM
Nlim	2,400 RPM
Min operating temperature, Tmin	-40 °C
Max operating temperature, Tmax	392 °C
Characteristic cage frequency, FTF	0.41 Hz
Characteristic rolling element frequency, BSF	4.96 Hz
Characteristic outer ring frequency, BPF0	6.08 Hz
Characteristic inner ring frequency, BPF1	8.92 Hz

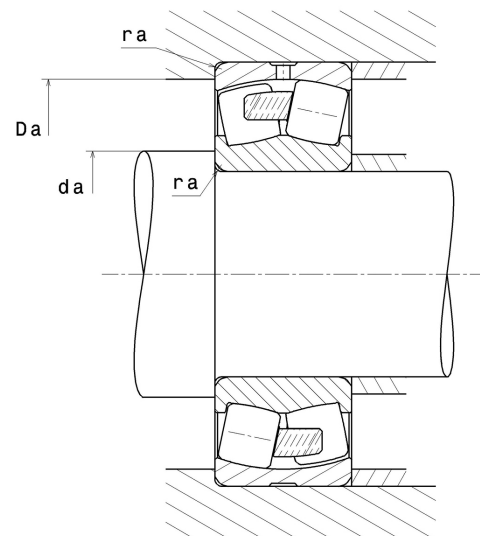

Abutment dimensions

da min	5.7874 "
Da max	10.3543 "
ra max	0.1181 "

Calculation factors

Equivalent dynamic radial load

$$P = X.F_r + Y.F_a$$

Fa / Fr ≤ e		Fa / Fr > e	
X	Y	X	Y
1	Y1	0.67	Y2

Equivalent static radial load

$$P_0 = X_0.F_r + Y_0.F_a$$

X ₀	Y ₀
1	Y0

The values for e, Y1, Y2 and Y0 are shown in the above table .