

PDF technical sheet 22318EAW33C4



Double row spherical roller bearings

Spherical roller bearing, pressed steel cage, groove and lubrication holes on outer ring

Product definition	
d	3.5433 "
D	7.4803 "
B	2.5197 "
d2	4.3346 "
D1	6.5000 "
rs min	0.1181 "
Number of lubrication holes	3
b	0.4567 "
k	0.1969 "
e	0.33
Y1	2.06
Y2	3.07
Y0	2.01
Radial clearance class	C4
Mass	29.22 oz
Brand	SNR



Product performance	
Dynamic load, C	668 kN
Static load, C0	652 kN
Fatigue limit load, Cu	58 kN
Nref	3,000 RPM
Nlim	3,500 RPM
Min operating temperature, Tmin	-40 °C
Max operating temperature, Tmax	392 °C
Characteristic cage frequency, FTF	0.40 Hz
Characteristic rolling element frequency, BSF	4.69 Hz
Characteristic outer ring frequency, BPF0	5.60 Hz
Characteristic inner ring frequency, BPF1	8.40 Hz

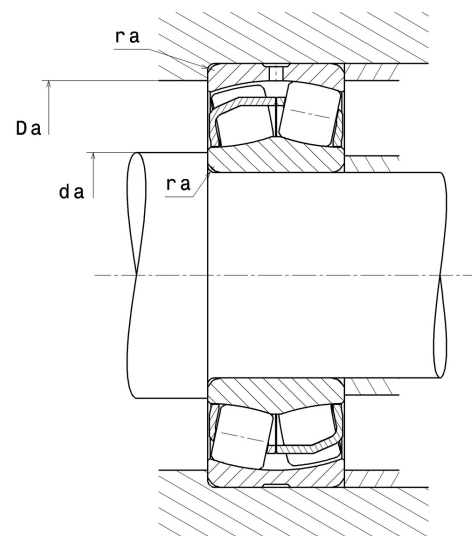

Abutment dimensions

da min	4.0945 "
Da max	6.9291 "
ra max	0.0984 "

Calculation factors

Equivalent dynamic radial load

$$P = X.F_r + Y.F_a$$

Fa / Fr ≤ e		Fa / Fr > e	
X	Y	X	Y
1	Y1	0.67	Y2

Equivalent static radial load

$$P_0 = X_0.F_r + Y_0.F_a$$

X ₀	Y ₀
1	Y0

The values for e, Y1, Y2 and Y0 are shown in the above table .