

PDF technical sheet 22316EKF800



Double row spherical roller bearings

Spherical roller bearing for vibratory applications, one-piece machined cage, groove and lubrication holes on outer ring, tapered bore 1:12, special C4 class clearance

Product definition	
d	3.1496 "
D	6.6929 "
B	2.2835 "
d2	3.8819 "
D1	5.8031 "
rs min	0.0827 "
Number of lubrication holes	3
b	0.4134 "
k	0.1969 "
Associated sleeve reference	H2316
e	0.34
Y1	2
Y2	2.98
Y0	1.96
Radial clearance class	C4 Special
Mass	21.52 oz
Brand	SNR

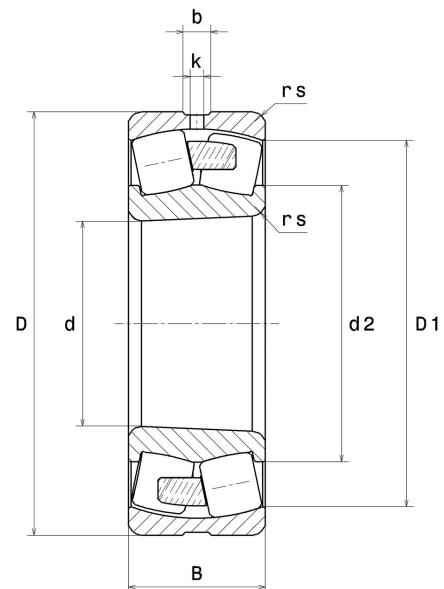

Product performance	
Dynamic load, C	541 kN
Static load, C0	522 kN
Fatigue limit load, Cu	47.30 kN
Nref	3,400 RPM
Nlim	3,900 RPM
Min operating temperature, Tmin	-40 °C
Max operating temperature, Tmax	392 °C
Characteristic cage frequency, FTF	0.40 Hz
Characteristic rolling element frequency, BSF	4.75 Hz
Characteristic outer ring frequency, BPF0	5.62 Hz
Characteristic inner ring frequency, BPF1	8.38 Hz

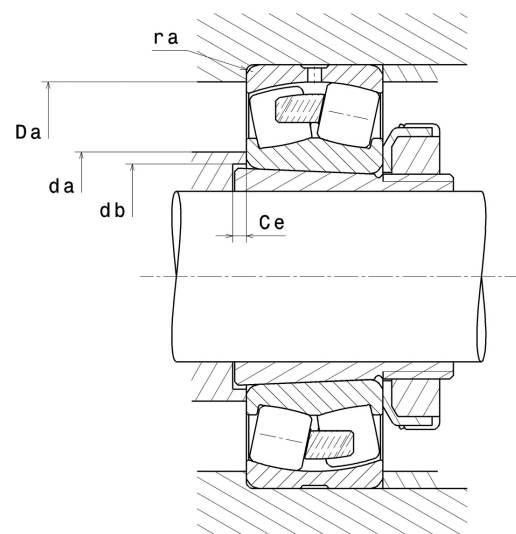

Abutment dimensions

da min	3.6220 "
db min	3.4646 "
Ce min	0.2362 "
Da max	6.2205 "
ra max	0.0787 "

Calculation factors

Equivalent dynamic radial load

$$P = X.Fr + Y.Fa$$

Fa / Fr ≤ e		Fa / Fr > e	
X	Y	X	Y
1	Y1	0.67	Y2

Equivalent static radial load

$$P_0 = X_0.Fr + Y_0.Fa$$

X ₀	Y ₀
1	Y0

The values for e, Y1, Y2 and Y0 are shown in the above table .