

## PDF technical sheet 22315EAW33C4



### Double row spherical roller bearings

Spherical roller bearing, pressed steel cage, groove and lubrication holes on outer ring

Product definition	
d	2.9528 "
D	6.2992 "
B	2.1654 "
d2	3.6181 "
D1	5.4449 "
rs min	0.0827 "
Number of lubrication holes	3
b	0.4134 "
k	0.1969 "
e	0.34
Y1	2
Y2	2.98
Y0	1.96
Radial clearance class	C4
Mass	17.93 oz
Brand	SNR



Product performance	
Dynamic load, C	491 kN
Static load, C0	467 kN
Fatigue limit load, Cu	43.30 kN
Nref	3,600 RPM
Nlim	4,200 RPM
Min operating temperature, Tmin	-40 °C
Max operating temperature, Tmax	392 °C
Characteristic cage frequency, FTF	0.40 Hz
Characteristic rolling element frequency, BSF	4.65 Hz
Characteristic outer ring frequency, BPF0	5.59 Hz
Characteristic inner ring frequency, BPF1	8.41 Hz

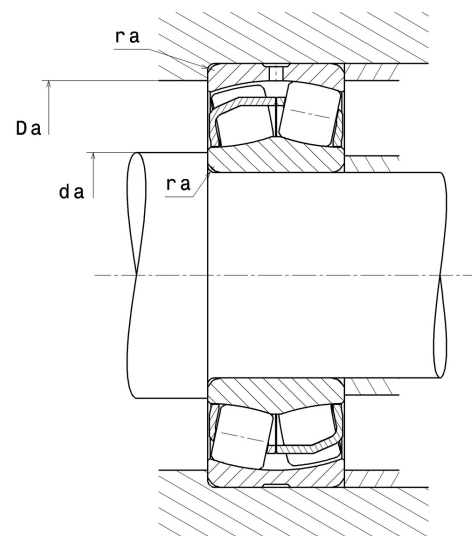

### Abutment dimensions

da min	3.4252 "
Da max	5.8268 "
ra max	0.0787 "

### Calculation factors

#### Equivalent dynamic radial load

$$P = X.F_r + Y.F_a$$

Fa / Fr ≤ e		Fa / Fr > e	
X	Y	X	Y
1	Y1	0.67	Y2

#### Equivalent static radial load

$$P_0 = X_0.F_r + Y_0.F_a$$

X <sub>0</sub>	Y <sub>0</sub>
1	Y0

The values for e, Y1, Y2 and Y0 are shown in the above table .