

PDF technical sheet 22310EMW33C4



Double row spherical roller bearings

Spherical roller bearing, one-piece machined cage, groove and lubrication holes on outer ring

Product definition	
d	1.9685 "
D	4.3307 "
B	1.5748 "
d2	2.5118 "
D1	3.6929 "
rs min	0.0787 "
Number of lubrication holes	3
b	0.2874 "
k	0.1378 "
e	0.36
Y1	1.87
Y2	2.79
Y0	1.83
Radial clearance class	C4
Mass	6.47 oz
Brand	SNR

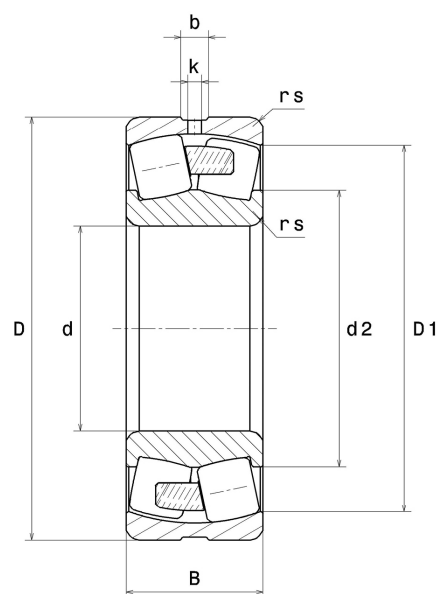

Product performance	
Dynamic load, C	250 kN
Static load, C0	232 kN
Fatigue limit load, Cu	20.40 kN
Nref	4,900 RPM
Nlim	6,100 RPM
Min operating temperature, Tmin	-40 °C
Max operating temperature, Tmax	392 °C
Characteristic cage frequency, FTF	0.40 Hz
Characteristic rolling element frequency, BSF	4.90 Hz
Characteristic outer ring frequency, BPF0	5.66 Hz
Characteristic inner ring frequency, BPF1	8.34 Hz

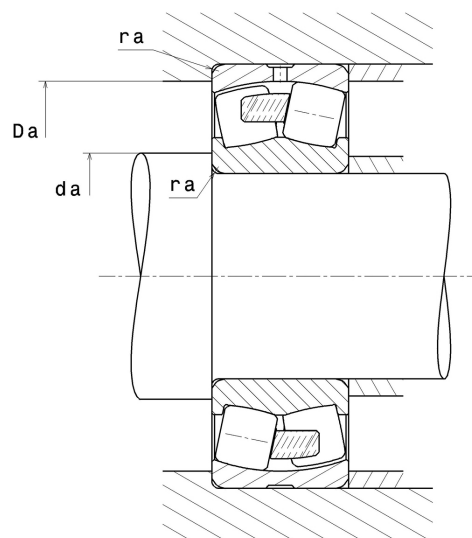

Abutment dimensions

da min	2.4016 "
Da max	3.8976 "
ra max	0.0787 "

Calculation factors

Equivalent dynamic radial load

$$P = X.F_r + Y.F_a$$

Fa / Fr ≤ e		Fa / Fr > e	
X	Y	X	Y
1	Y1	0.67	Y2

Equivalent static radial load

$$P_0 = X_0.F_r + Y_0.F_a$$

X ₀	Y ₀
1	Y0

The values for e, Y1, Y2 and Y0 are shown in the above table .