

## PDF technical sheet 22309EMW33



### Double row spherical roller bearings

Spherical roller bearing, one-piece machined cage, groove and lubrication holes on outer ring

Product definition	
d	1.7717 "
D	3.9370 "
B	1.4173 "
d2	2.2835 "
D1	3.3780 "
rs min	0.0591 "
Number of lubrication holes	3
b	0.2520 "
k	0.1181 "
e	0.36
Y1	1.9
Y2	2.83
Y0	1.86
Radial clearance class	CN
Mass	4.83 oz
Brand	SNR

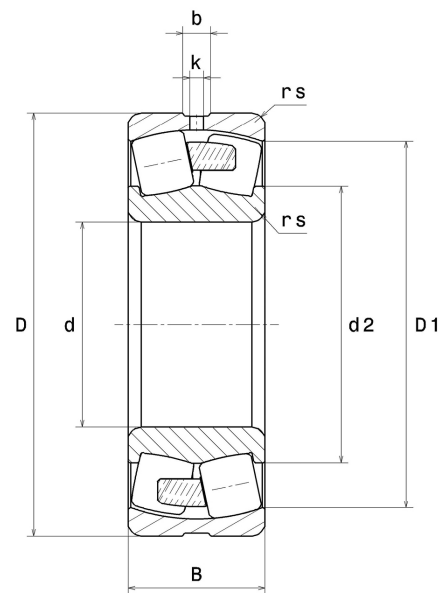

Product performance	
Dynamic load, C	206 kN
Static load, C0	187 kN
Fatigue limit load, Cu	17.20 kN
Nref	5,300 RPM
Nlim	6,700 RPM
Min operating temperature, Tmin	-40 °C
Max operating temperature, Tmax	392 °C
Characteristic cage frequency, FTF	0.40 Hz
Characteristic rolling element frequency, BSF	4.85 Hz
Characteristic outer ring frequency, BPF0	5.65 Hz
Characteristic inner ring frequency, BPF1	8.35 Hz

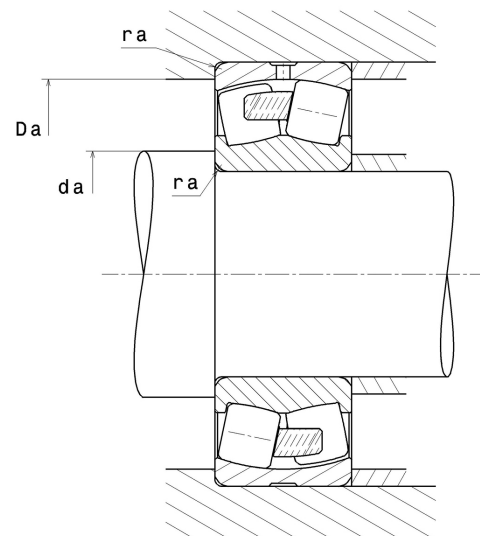

### Abutment dimensions

da min	2.1260 "
Da max	3.5827 "
ra max	0.0591 "

### Calculation factors

#### Equivalent dynamic radial load

$$P = X.F_r + Y.F_a$$

Fa / Fr ≤ e		Fa / Fr > e	
X	Y	X	Y
1	Y1	0.67	Y2

#### Equivalent static radial load

$$P_0 = X_0.F_r + Y_0.F_a$$

X <sub>0</sub>	Y <sub>0</sub>
1	Y0

The values for e, Y1, Y2 and Y0 are shown in the above table .