

PDF technical sheet 22238EMKW33



Double row spherical roller bearings

Spherical roller bearing, one-piece machined cage, groove and lubrication holes on outer ring, tapered bore 1:12

Product definition	
d	7.4803 "
D	13.3858 "
B	3.6220 "
D1	12.0000 "
rs min	0.1575 "
Number of lubrication holes	3
b	0.7717 "
k	0.3543 "
Associated sleeve reference	H3138
e	0.25
Y1	2.74
Y2	4.08
Y0	2.68
Radial clearance class	CN
Mass	123.46 oz
Brand	SNR

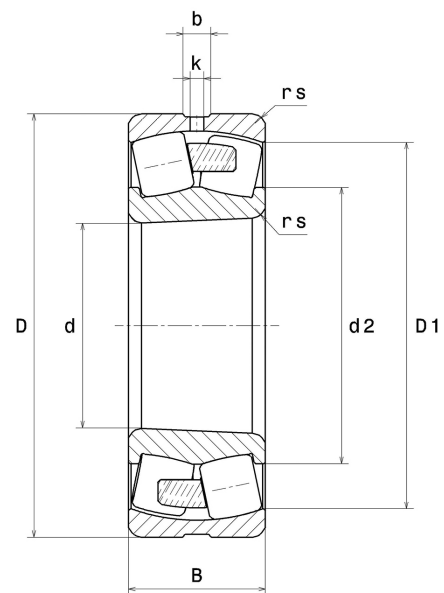

Product performance	
Dynamic load, C	1,620 kN
Static load, C0	1,870 kN
Fatigue limit load, Cu	159 kN
Nref	1,600 RPM
Nlim	2,400 RPM
Min operating temperature, Tmin	-40 °C
Max operating temperature, Tmax	392 °C
Characteristic cage frequency, FTF	0.42 Hz
Characteristic rolling element frequency, BSF	6.11 Hz
Characteristic outer ring frequency, BPF0	7.58 Hz
Characteristic inner ring frequency, BPF1	10.42 Hz



Abutment dimensions

da min	8.1496 "
Da max	12.7165 "
ra max	0.1181 "

Calculation factors

Equivalent dynamic radial load

$$P = X.F_r + Y.F_a$$

Fa / Fr ≤ e		Fa / Fr > e	
X	Y	X	Y
1	Y1	0.67	Y2

Equivalent static radial load

$$P_0 = X_0.F_r + Y_0.F_a$$

X ₀	Y ₀
1	Y0

The values for e, Y1, Y2 and Y0 are shown in the above table .