

PDF technical sheet 22232EMW33C4



Double row spherical roller bearings

Spherical roller bearing, one-piece machined cage, groove and lubrication holes on outer ring

Product definition	
d	6.2992 "
D	11.4173 "
B	3.1496 "
D1	10.1850 "
rs min	0.1181 "
Number of lubrication holes	3
b	0.6654 "
k	0.3150 "
e	0.25
Y1	2.69
Y2	4
Y0	2.63
Radial clearance class	C4
Mass	81.84 oz
Brand	SNR

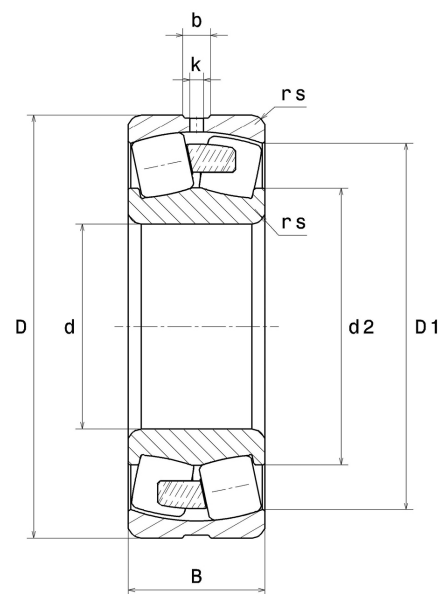

Product performance	
Dynamic load, C	1,220 kN
Static load, C0	1,390 kN
Fatigue limit load, Cu	120 kN
Nref	2,000 RPM
Nlim	2,800 RPM
Min operating temperature, Tmin	-40 °C
Max operating temperature, Tmax	392 °C
Characteristic cage frequency, FTF	0.42 Hz
Characteristic rolling element frequency, BSF	6.17 Hz
Characteristic outer ring frequency, BPF0	7.60 Hz
Characteristic inner ring frequency, BPF1	10.40 Hz

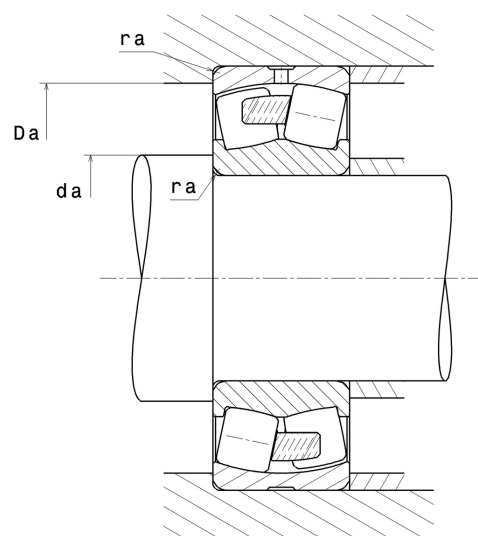

Abutment dimensions

da min	6.8504 "
Da max	10.8661 "
ra max	0.0984 "

Calculation factors

Equivalent dynamic radial load

$$P = X.F_r + Y.F_a$$

Fa / Fr ≤ e		Fa / Fr > e	
X	Y	X	Y
1	Y1	0.67	Y2

Equivalent static radial load

$$P_0 = X_0.F_r + Y_0.F_a$$

X ₀	Y ₀
1	Y0

The values for e, Y1, Y2 and Y0 are shown in the above table .