

PDF technical sheet 22224EMW33



Double row spherical roller bearings

Spherical roller bearing, one-piece machined cage, groove and lubrication holes on outer ring

Product definition	
d	4.7244 "
D	8.4646 "
B	2.2835 "
D1	7.5709 "
rs min	0.0827 "
Number of lubrication holes	3
b	0.4803 "
k	0.2362 "
e	0.25
Y1	2.74
Y2	4.08
Y0	2.68
Radial clearance class	CN
Mass	30.97 oz
Brand	SNR

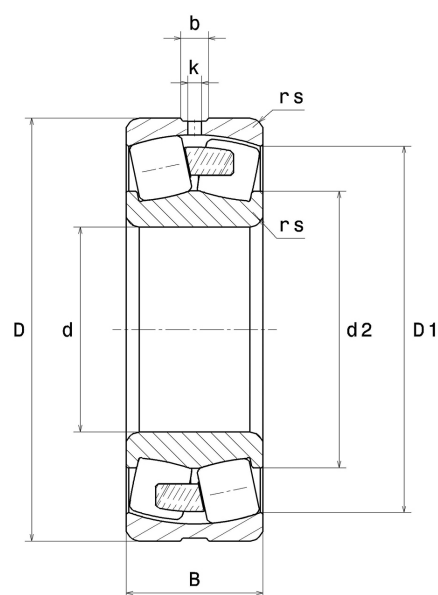

Product performance	
Dynamic load, C	688 kN
Static load, C0	753 kN
Fatigue limit load, Cu	71.30 kN
Nref	3,000 RPM
Nlim	3,800 RPM
Min operating temperature, Tmin	-40 °C
Max operating temperature, Tmax	392 °C
Characteristic cage frequency, FTF	0.42 Hz
Characteristic rolling element frequency, BSF	6.27 Hz
Characteristic outer ring frequency, BPF0	7.62 Hz
Characteristic inner ring frequency, BPF1	10.38 Hz

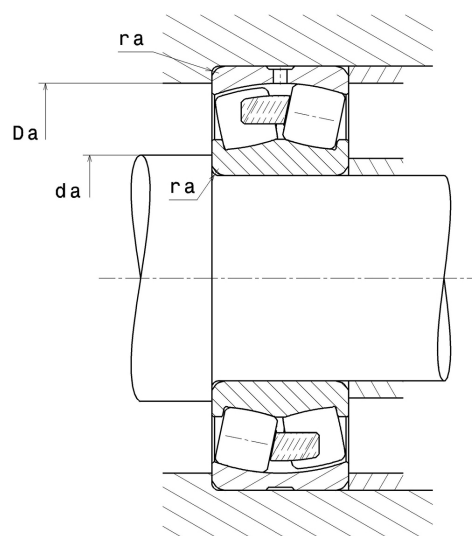

Abutment dimensions

da min	5.1969 "
Da max	7.9921 "
ra max	0.0787 "

Calculation factors

Equivalent dynamic radial load

$$P = X.F_r + Y.F_a$$

Fa / Fr ≤ e		Fa / Fr > e	
X	Y	X	Y
1	Y1	0.67	Y2

Equivalent static radial load

$$P_0 = X_0.F_r + Y_0.F_a$$

X ₀	Y ₀
1	Y0

The values for e, Y1, Y2 and Y0 are shown in the above table .