

PDF technical sheet 2222EMKW33



Double row spherical roller bearings

Spherical roller bearing, one-piece machined cage, groove and lubrication holes on outer ring, tapered bore 1:12

Product definition	
d	4.3307 "
D	7.8740 "
B	2.0866 "
D1	7.0236 "
rs min	0.0827 "
Number of lubrication holes	3
b	0.4803 "
k	0.2362 "
Associated sleeve reference	H322
e	0.25
Y1	2.69
Y2	4
Y0	2.63
Radial clearance class	CN
Mass	25.48 oz
Brand	SNR

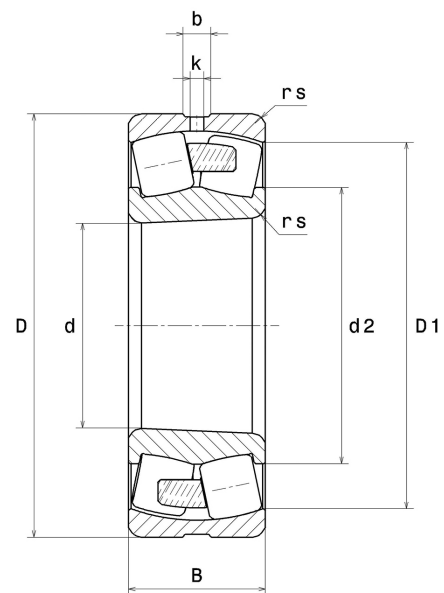

Product performance	
Dynamic load, C	602 kN
Static load, C0	643 kN
Fatigue limit load, Cu	64.30 kN
Nref	3,300 RPM
Nlim	4,100 RPM
Min operating temperature, Tmin	-40 °C
Max operating temperature, Tmax	392 °C
Characteristic cage frequency, FTF	0.42 Hz
Characteristic rolling element frequency, BSF	6.10 Hz
Characteristic outer ring frequency, BPF0	7.58 Hz
Characteristic inner ring frequency, BPF1	10.42 Hz

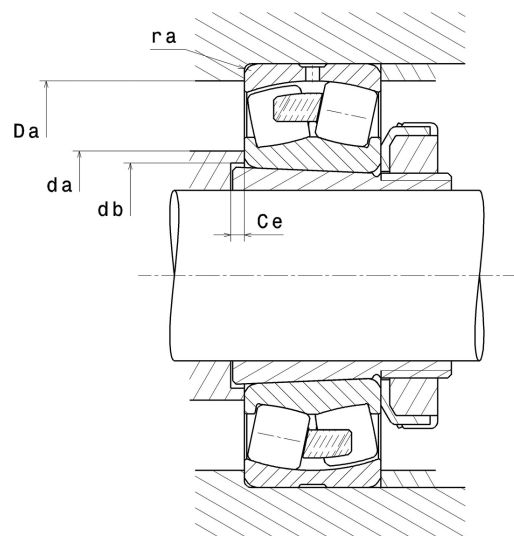

Abutment dimensions

da min	4.8031 "
Da max	7.4016 "
ra max	0.0787 "

Calculation factors

Equivalent dynamic radial load

$$P = X.F_r + Y.F_a$$

Fa / Fr ≤ e		Fa / Fr > e	
X	Y	X	Y
1	Y1	0.67	Y2

Equivalent static radial load

$$P_0 = X_0.F_r + Y_0.F_a$$

X ₀	Y ₀
1	Y0

The values for e, Y1, Y2 and Y0 are shown in the above table .