

## PDF technical sheet 22218EAW33C4



### Double row spherical roller bearings

Spherical roller bearing, pressed steel cage, groove and lubrication holes on outer ring

Product definition	
d	3.5433 "
D	6.2992 "
B	1.5748 "
d2	4.1457 "
D1	5.6378 "
rs min	0.0787 "
Number of lubrication holes	3
b	0.4016 "
k	0.1772 "
e	0.23
Y1	2.9
Y2	4.31
Y0	2.83
Radial clearance class	C4
Mass	11.58 oz
Brand	SNR



Product performance	
Dynamic load, C	384 kN
Static load, C0	398 kN
Fatigue limit load, Cu	43.10 kN
Nref	3,900 RPM
Nlim	5,100 RPM
Min operating temperature, Tmin	-40 °C
Max operating temperature, Tmax	392 °C
Characteristic cage frequency, FTF	0.42 Hz
Characteristic rolling element frequency, BSF	6.24 Hz
Characteristic outer ring frequency, BPF0	7.61 Hz
Characteristic inner ring frequency, BPF1	10.39 Hz

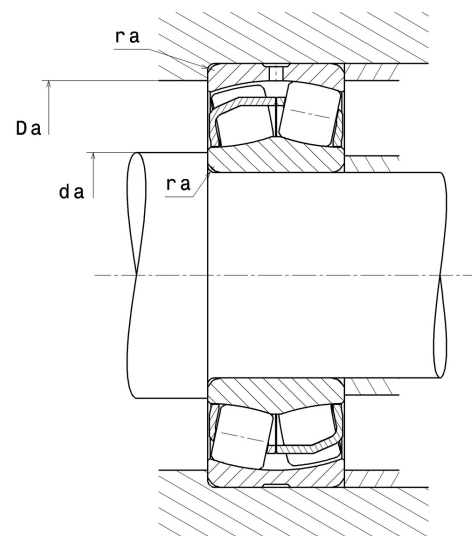

### Abutment dimensions

da min	3.9764 "
Da max	5.8661 "
ra max	0.0787 "

### Calculation factors

#### Equivalent dynamic radial load

$$P = X.F_r + Y.F_a$$

Fa / Fr ≤ e		Fa / Fr > e	
X	Y	X	Y
1	Y1	0.67	Y2

#### Equivalent static radial load

$$P_0 = X_0.F_r + Y_0.F_a$$

X <sub>0</sub>	Y <sub>0</sub>
1	Y0

The values for e, Y1, Y2 and Y0 are shown in the above table .