

## PDF technical sheet 22215EMW33C4



### Double row spherical roller bearings

Spherical roller bearing, one-piece machined cage, groove and lubrication holes on outer ring

Product definition	
d	2.9528 "
D	5.1181 "
B	1.2205 "
D1	4.6378 "
rs min	0.0591 "
Number of lubrication holes	3
b	0.2913 "
k	0.1378 "
e	0.22
Y1	3.13
Y2	4.67
Y0	3.06
Radial clearance class	C4
Mass	6.07 oz
Brand	SNR

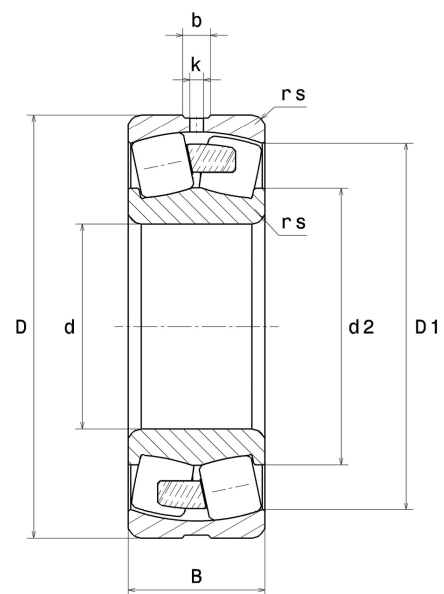

Product performance	
Dynamic load, C	244 kN
Static load, C0	249 kN
Fatigue limit load, Cu	30.20 kN
Nref	4,600 RPM
Nlim	6,200 RPM
Min operating temperature, Tmin	-40 °C
Max operating temperature, Tmax	392 °C
Characteristic cage frequency, FTF	0.43 Hz
Characteristic rolling element frequency, BSF	6.71 Hz
Characteristic outer ring frequency, BPF0	8.13 Hz
Characteristic inner ring frequency, BPF1	10.87 Hz

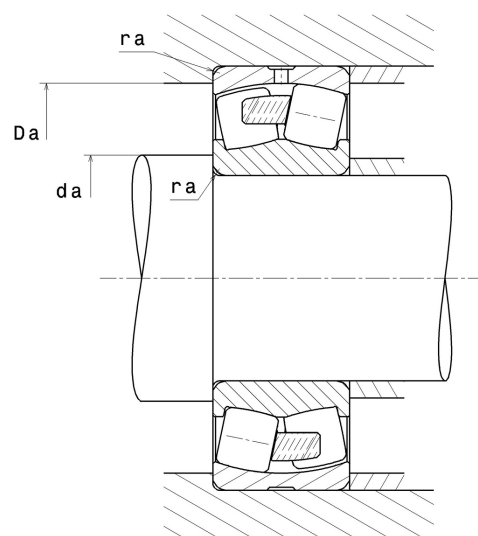

### Abutment dimensions

da min	3.3071 "
Da max	4.7638 "
ra max	0.0591 "

### Calculation factors

#### Equivalent dynamic radial load

$$P = X.F_r + Y.F_a$$

Fa / Fr ≤ e		Fa / Fr > e	
X	Y	X	Y
1	Y1	0.67	Y2

#### Equivalent static radial load

$$P_0 = X_0.F_r + Y_0.F_a$$

X <sub>0</sub>	Y <sub>0</sub>
1	Y0

The values for e, Y1, Y2 and Y0 are shown in the above table .