

PDF technical sheet 22215EAW33C3



Double row spherical roller bearings

Spherical roller bearing, pressed steel cage, groove and lubrication holes on outer ring

Product definition	
d	2.9528 "
D	5.1181 "
B	1.2205 "
d2	3.4803 "
D1	4.6378 "
rs min	0.0591 "
Number of lubrication holes	3
b	0.2913 "
k	0.1378 "
e	0.22
Y1	3.13
Y2	4.67
Y0	3.06
Radial clearance class	C3
Mass	5.80 oz
Brand	SNR



Product performance	
Dynamic load, C	244 kN
Static load, C0	249 kN
Fatigue limit load, Cu	30.20 kN
Nref	4,600 RPM
Nlim	6,200 RPM
Min operating temperature, Tmin	-40 °C
Max operating temperature, Tmax	392 °C
Characteristic cage frequency, FTF	0.43 Hz
Characteristic rolling element frequency, BSF	6.71 Hz
Characteristic outer ring frequency, BPF0	8.13 Hz
Characteristic inner ring frequency, BPF1	10.87 Hz

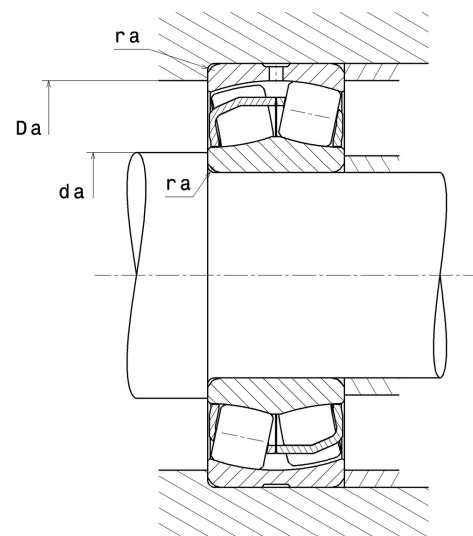

Abutment dimensions

da min	3.3071 "
Da max	4.7638 "
ra max	0.0591 "

Calculation factors

Equivalent dynamic radial load

$$P = X.F_r + Y.F_a$$

Fa / Fr ≤ e		Fa / Fr > e	
X	Y	X	Y
1	Y1	0.67	Y2

Equivalent static radial load

$$P_0 = X_0.F_r + Y_0.F_a$$

X ₀	Y ₀
1	Y0

The values for e, Y1, Y2 and Y0 are shown in the above table .