

## PDF technical sheet 22210EMW33C3



### Double row spherical roller bearings

Spherical roller bearing, one-piece machined cage, groove and lubrication holes on outer ring

Product definition	
d	1.9685 "
D	3.5433 "
B	0.9055 "
D1	3.1772 "
rs min	0.0433 "
Number of lubrication holes	3
b	0.2283 "
k	0.0984 "
e	0.24
Y1	2.84
Y2	4.23
Y0	2.78
Radial clearance class	C3
Mass	2.06 oz
Brand	SNR

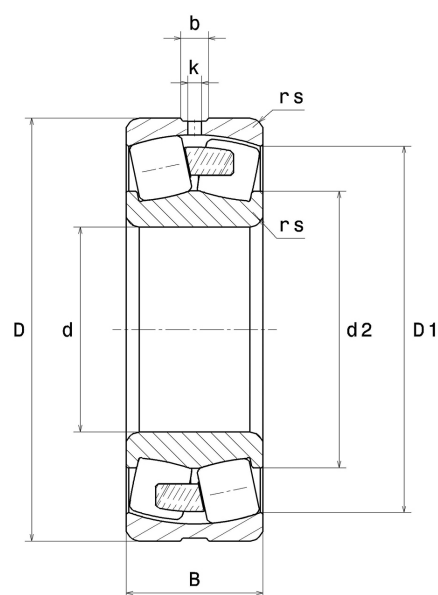

Product performance	
Dynamic load, C	125 kN
Static load, C0	117 kN
Fatigue limit load, Cu	13.70 kN
Nref	6,700 RPM
Nlim	9,100 RPM
Min operating temperature, Tmin	-40 °C
Max operating temperature, Tmax	392 °C
Characteristic cage frequency, FTF	0.42 Hz
Characteristic rolling element frequency, BSF	6.34 Hz
Characteristic outer ring frequency, BPF0	7.21 Hz
Characteristic inner ring frequency, BPF1	9.79 Hz

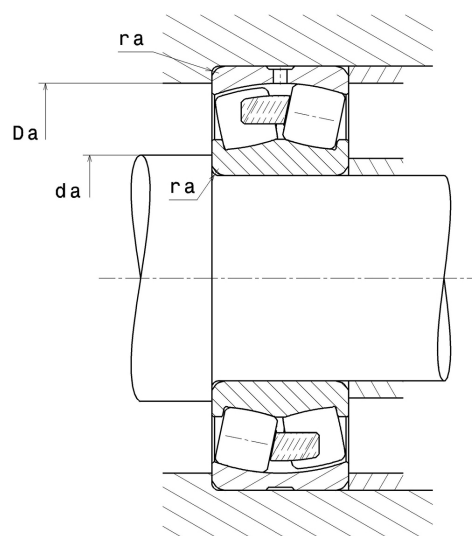

### Abutment dimensions

da min	2.2441 "
Da max	3.2677 "
ra max	0.0394 "

### Calculation factors

#### Equivalent dynamic radial load

$$P = X.F_r + Y.F_a$$

Fa / Fr ≤ e		Fa / Fr > e	
X	Y	X	Y
1	Y1	0.67	Y2

#### Equivalent static radial load

$$P_0 = X_0.F_r + Y_0.F_a$$

X <sub>0</sub>	Y <sub>0</sub>
1	Y0

The values for e, Y1, Y2 and Y0 are shown in the above table .