

## PDF technical sheet 22208EMW33



### Double row spherical roller bearings

Spherical roller bearing, one-piece machined cage, groove and lubrication holes on outer ring

Product definition	
d	1.5748 "
D	3.1496 "
B	0.9055 "
D1	2.7874 "
rs min	0.0433 "
Number of lubrication holes	3
b	0.2126 "
k	0.0984 "
e	0.27
Y1	2.47
Y2	3.68
Y0	2.41
Radial clearance class	CN
Mass	1.76 oz
Brand	SNR

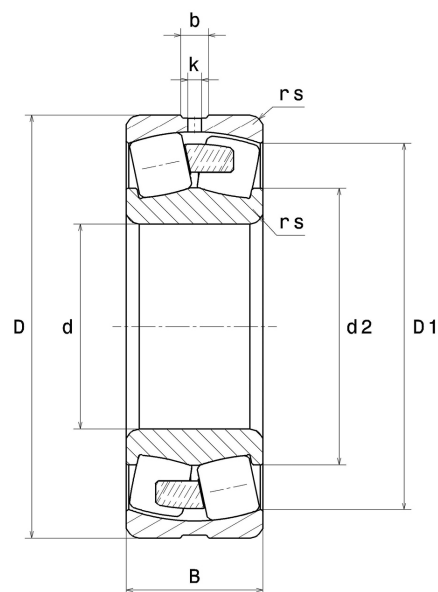

Product performance	
Dynamic load, C	110 kN
Static load, C0	98 kN
Fatigue limit load, Cu	10.30 kN
Nref	8,300 RPM
Nlim	11,000 RPM
Min operating temperature, Tmin	-40 °C
Max operating temperature, Tmax	392 °C
Characteristic cage frequency, FTF	0.42 Hz
Characteristic rolling element frequency, BSF	5.62 Hz
Characteristic outer ring frequency, BPF0	6.23 Hz
Characteristic inner ring frequency, BPF1	8.78 Hz

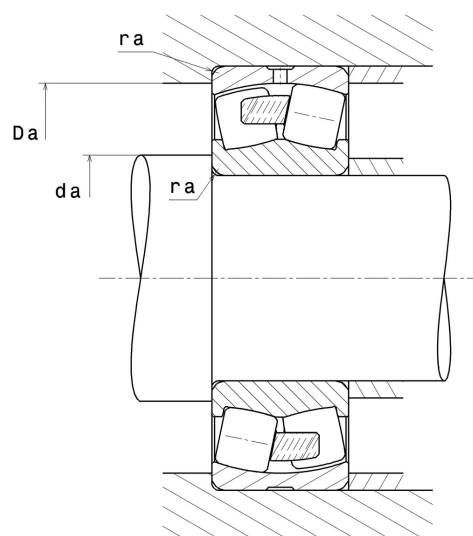

### Abutment dimensions

da min	1.8504 "
Da max	2.8740 "
ra max	0.0394 "

### Calculation factors

#### Equivalent dynamic radial load

$$P = X.F_r + Y.F_a$$

Fa / Fr ≤ e		Fa / Fr > e	
X	Y	X	Y
1	Y1	0.67	Y2

#### Equivalent static radial load

$$P_0 = X_0.F_r + Y_0.F_a$$

X <sub>0</sub>	Y <sub>0</sub>
1	Y0

The values for e, Y1, Y2 and Y0 are shown in the above table .