

PDF technical sheet 21313VKC3



Double row spherical roller bearings

Spherical roller bearing, pressed steel cage, tapered bore 1:12

Product definition	
d	2.5591 "
D	5.5118 "
B	1.2992 "
d2	3.3780 "
D1	4.7126 "
rs min	0.0827 "
Number of lubrication holes	
Associated sleeve reference	H313
e	0.23
Y1	2.91
Y2	4.33
Y0	2.84
Radial clearance class	C3
Mass	8.40 oz
Brand	SNR

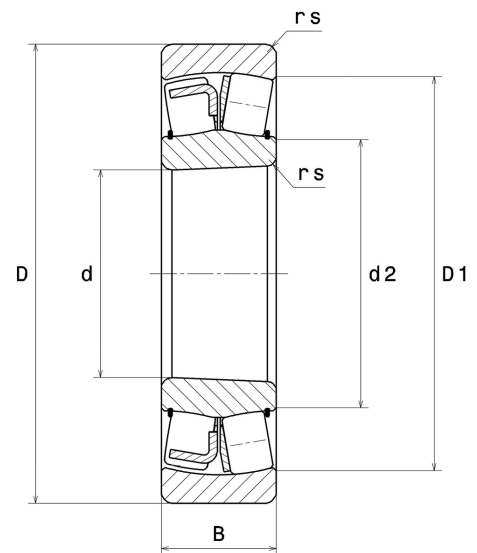

Product performance	
Dynamic load, C	236 kN
Static load, C0	215 kN
Fatigue limit load, Cu	28.60 kN
Nref	4,400 RPM
Nlim	5,900 RPM
Min operating temperature, Tmin	-40 °C
Max operating temperature, Tmax	392 °C
Characteristic cage frequency, FTF	0.42 Hz
Characteristic rolling element frequency, BSF	5.74 Hz
Characteristic outer ring frequency, BPF0	6.25 Hz
Characteristic inner ring frequency, BPF1	8.76 Hz

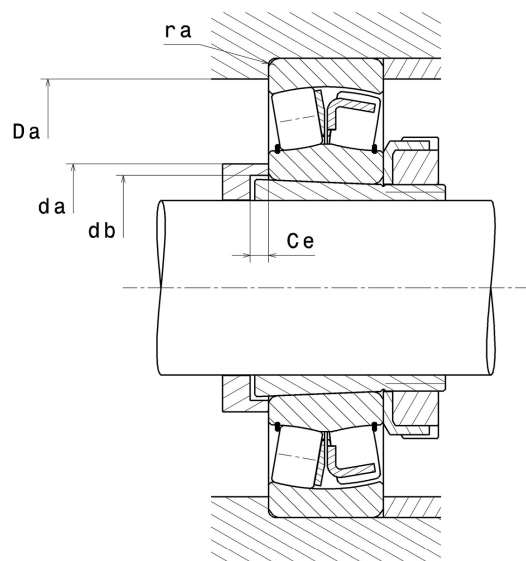

Abutment dimensions

da min	3.0315 "
Da max	5.0394 "
ra max	0.0787 "

Calculation factors

Equivalent dynamic radial load

$$P = X.F_r + Y.F_a$$

Fa / Fr ≤ e		Fa / Fr > e	
X	Y	X	Y
1	Y1	0.67	Y2

Equivalent static radial load

$$P_0 = X_0.F_r + Y_0.F_a$$

X ₀	Y ₀
1	Y0

The values for e, Y1, Y2 and Y0 are shown in the above table .