

PDF technical sheet 10X22207EAKW33EE



Double row spherical roller bearings

Spherical roller bearing, pressed steel cage, groove and lubrication holes on outer ring, tapered bore 1:12, non ISO width, contact seals on both sides

Product definition

d	1.3780 "
D	2.8346 "
B	1.1024 "
d2	1.6850 "
D1	2.5630 "
rs min	0.0433 "
Number of lubrication holes	3
b	0.1929 "
k	0.0787 "
e	0.31
Y1	2.21
Y2	3.29
Y0	2.16
Radial clearance class	CN
Mass	1.74 oz
Brand	SNR

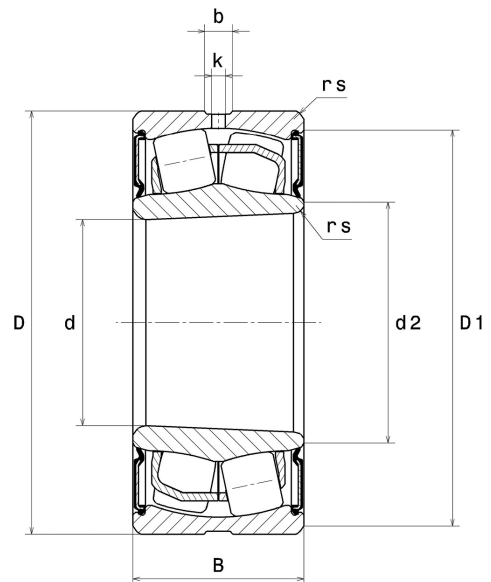

Product performance

Dynamic load, C	100 kN
Static load, C0	92 kN
Fatigue limit load, Cu	8.80 kN
Nlim	2,600 RPM
Min operating temperature, Tmin	14 °C
Max operating temperature, Tmax	248 °C
Characteristic cage frequency, FTF	0.42 Hz
Characteristic rolling element frequency, BSF	5.76 Hz
Characteristic outer ring frequency, BPF0	6.68 Hz
Characteristic inner ring frequency, BPF1	9.32 Hz

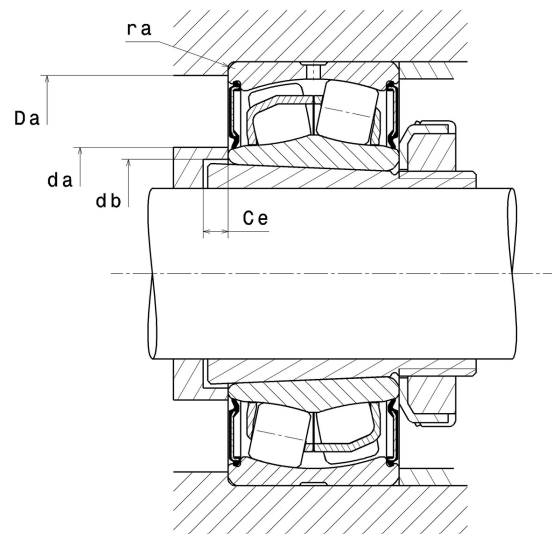

Abutment dimensions

da min	1.6535 "
da max	1.6850 "
Da max	2.5630 "
ra max	0.0394 "

Calculation factors

Equivalent dynamic radial load

$$P = X \cdot Fr + Y \cdot Fa$$

Fa / Fr ≤ e		Fa / Fr > e	
X	Y	X	Y
1	Y1	0.67	Y2

Equivalent static radial load

$$P_0 = X_0 \cdot Fr + Y_0 \cdot Fa$$

X ₀	Y ₀
1	Y0

The values for e, Y1, Y2 and Y0 are shown in the above table .