

PDF technical sheet NU219EMJ30



Single row cylindrical roller bearings

Single row cylindrical roller bearing, floating, separable, brass cage

Product definition	
d	3.7402 "
D	6.6929 "
B	1.2598 "
E	6.0827 "
F	4.4291 "
D1	5.8504 "
rs min	0.0827 "
r1s min	0.0827 "
Radial clearance class	C3
Mass (without HJ ring)	10.97 oz
Brand	SNR

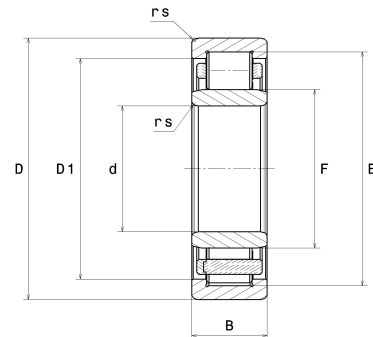

Product performance	
Dynamic load, C	222 kN
Static load, C0	267 kN
Fatigue limit load, Cu	29.90 kN
Nref	3,700 RPM
Nlim	6,200 RPM
Min operating temperature, Tmin	-40 °C
Max operating temperature, Tmax	248 °C
Characteristic cage frequency, FTF	0.42 Hz
Characteristic rolling element frequency, BSF	6.20 Hz
Characteristic outer ring frequency, BPF0	7.16 Hz
Characteristic inner ring frequency, BPF1	9.84 Hz

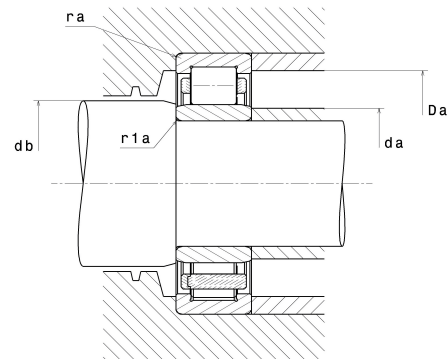

Abutment dimensions	
da min	4.1732 "
da max	4.3701 "
Da max	6.2598 "
ra max	0.0787 "
r1a max	0.0787 "

Calculation factors

Equivalent dynamic radial load

$$P = Fr$$

Equivalent static radial load

$$P_0 = Fr$$