

## PDF technical sheet NJ205EC3



### Single row cylindrical roller bearings

Single row cylindrical roller bearing, single direction for axial loads, separable, pressed steel cage.

Product definition	
d	0.9843 "
D	2.0472 "
B	0.5906 "
E	1.8307 "
F	1.2402 "
d1	1.3583 "
D1	1.7126 "
rs min	0.0394 "
r1s min	0.0236 "
Radial clearance class	C3
Mass (without HJ ring)	0.52 oz
Brand	SNR

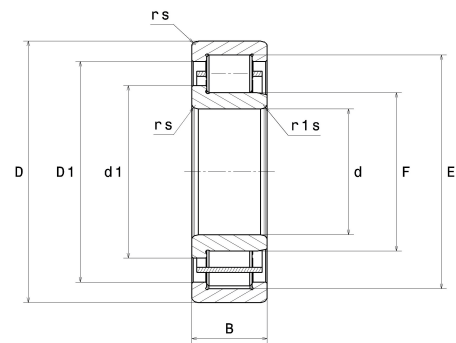

Product performance	
Dynamic load, C	28.50 kN
Static load, C0	26.70 kN
Fatigue limit load, Cu	3.25 kN
Nref	12,000 RPM
Nlim	17,000 RPM
Min operating temperature, Tmin	-40 °C
Max operating temperature, Tmax	248 °C
Characteristic cage frequency, FTF	0.40 Hz
Characteristic rolling element frequency, BSF	5.01 Hz
Characteristic outer ring frequency, BPF0	5.25 Hz
Characteristic inner ring frequency, BPF1	7.75 Hz

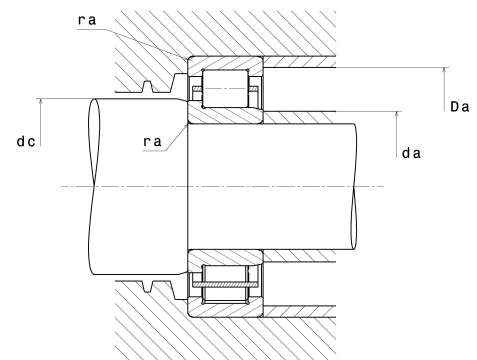

Abutment dimensions	
da min	1.1811 "
da max	1.2205 "
db min	1.3386 "
dc min	1.4567 "
Da max	1.8504 "
ra max	0.0394 "
r1a max	0.0236 "

### Calculation factors

Equivalent dynamic radial load

$$P = Fr$$

Equivalent static radial load

$$P_0 = Fr$$