

PDF technical sheet UC326G2L3



Insert bearings

spherical outer diameter, fixing by socket set screw, triple lip seal

Product definition	
B	5.3150 "
C	2.6772 "
C1	0.9055 "
d	5.1181 "
D	11.0236 "
G	M20x1,5
m	0.7874 "
r	4
S	2.1260 "
SW	0.3937 "

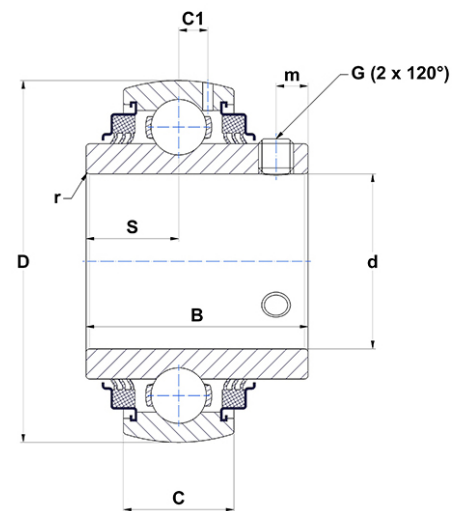

m.ncatalog.fo.featuresotherperformance	
C	252 kN
C0	242 kN
T min.	-4 °C
T max.	212 °C

Other features	
Weight	81.13 oz
Recommended tightening torque for set screw	120 Nm