

PDF technical sheet UC324G2L3

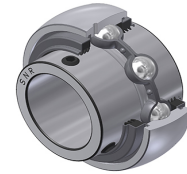

Insert bearings

spherical outer diameter, fixing by socket set screw, triple lip seal

Product definition	
B	4.9606 "
C	2.5197 "
C1	0.8661 "
d	4.7244 "
D	10.2362 "
G	M18x1,5
m	0.7087 "
r	3
S	2.0079 "
SW	0.3543 "

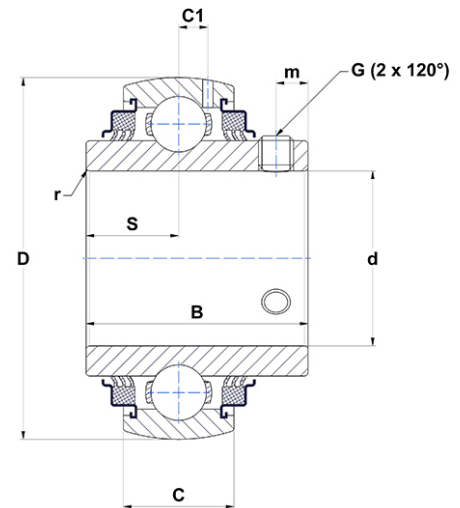

m.ncatalog.fo.featuresotherperformance	
C	228 kN
C0	208 kN
T min.	-4 °C
T max.	212 °C

Other features	
Weight	65.26 oz
Recommended tightening torque for set screw	75 Nm