

PDF technical sheet UC319G2L3



Insert bearings

spherical outer diameter, fixing by socket set screw, triple lip seal

Product definition	
B	4.0551 "
C	1.9685 "
C1	0.6575 "
d	3.7402 "
D	7.8740 "
G	M16x1,5
m	0.7087 "
r	3
S	1.6142 "
SW	0.3150 "

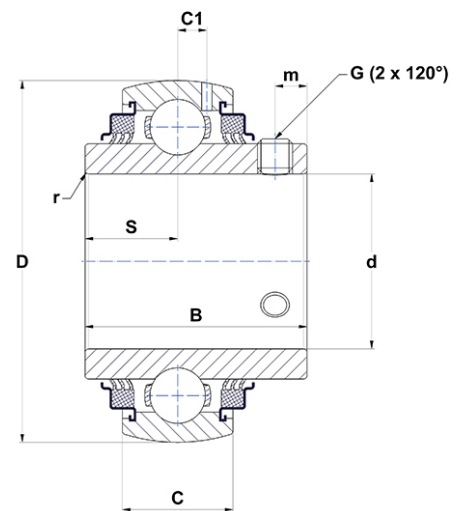

m.ncatalog.fo.featuresotherperformance	
C	156 kN
C0	122 kN
T min.	-4 °C
T max.	212 °C

Other features	
Weight	31.43 oz
Recommended tightening torque for set screw	64 Nm