

PDF technical sheet UC31548G2



Insert bearings

zinc-coated insert, spherical outer diameter with locking pin, fixing by socket set screw, seal with slinger, food grease

Product definition	
B	3.2283 "
C	1.6535 "
C1	0.5315 "
d	3.0000 "
D	6.2992 "
G	1/220UNF
m	0.5512 "
r	2.5
S	1.2598 "
SW	0.2500 "

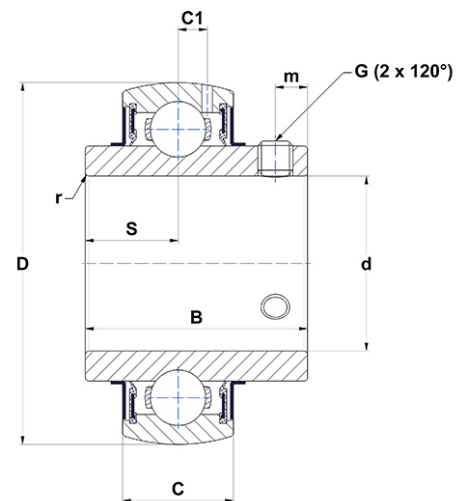

m.ncatalog.fo.featuresotherperformance	
C	113.36 kN
C0	76.80 kN
T min.	-4 °C
T max.	212 °C

Other features	
Weight	14.96 oz
Recommended tightening torque for set screw	33.90 Nm