

## PDF technical sheet UC312G2L3



### Insert bearings

spherical outer diameter, fixing by socket set screw, triple lip seal

Product definition	
B	2.7953 "
C	1.4173 "
C1	0.4449 "
d	2.3622 "
D	5.1181 "
G	M12x1,25
m	0.4724 "
r	2
S	1.0236 "
SW	0.2362 "

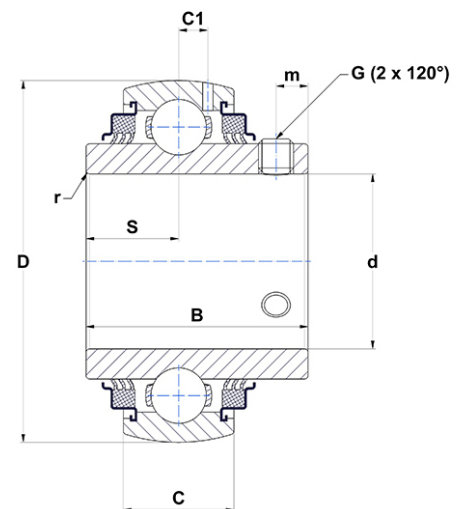

m.ncatalog.fo.featuresotherperformance	
C	81.60 kN
C0	51.80 kN
T min.	-4 °C
T max.	212 °C

Other features	
Weight	9.17 oz
Recommended tightening torque for set screw	33 Nm