

PDF technical sheet UC31132G2



Insert bearings

zinc-coated insert, spherical outer diameter with locking pin, fixing by socket set screw, seal with slinger, food grease

Product definition	
B	2.5984 "
C	1.3386 "
C1	0.4173 "
d	2.0000 "
D	4.7244 "
G	7/1620UNF
m	0.4724 "
r	2
S	0.9843 "
SW	0.2187 "

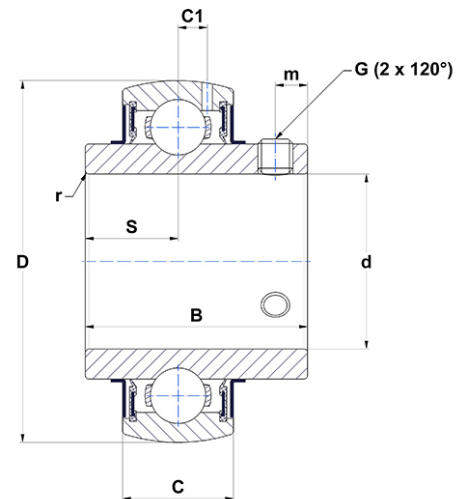

m.ncatalog.fo.featuresotherperformance	
C	71.50 kN
C0	44.80 kN
T min.	-4 °C
T max.	212 °C

Other features	
Weight	7.34 oz
Recommended tightening torque for set screw	27.10 Nm