

## PDF technical sheet UC30928G2T04



### Insert bearings

zinc-coated insert, spherical outer diameter with locking pin, fixing by socket set screw, seal with slinger, food grease

Product definition	
B	2.2441 "
C	1.1811 "
C1	0.3543 "
d	1.7500 "
D	3.9370 "
G	3/824UNF
m	0.3937 "
r	2
S	0.8661 "
SW	0.1875 "

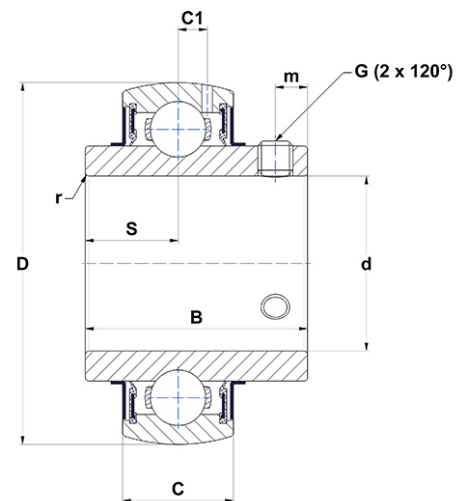

m.ncatalog.fo.featuresotherperformance	
C	53 kN
C0	31.80 kN
T min.	-40 °C
T max.	212 °C

Other features	
Weight	4.59 oz
Recommended tightening torque for set screw	16.80 Nm