

PDF technical sheet UC30723G2



Insert bearings

zinc-coated insert, spherical outer diameter with locking pin, fixing by socket set screw, seal with slinger, food grease

Product definition	
B	1.8898 "
C	0.9843 "
C1	0.2835 "
d	1.4375 "
D	3.1496 "
G	5/1624UNF
m	0.3150 "
r	2
S	0.7480 "
SW	0.1563 "

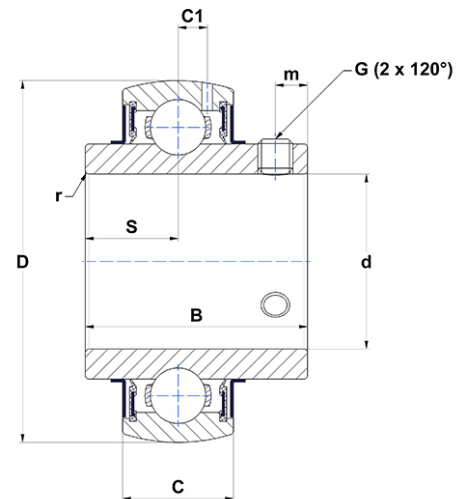

m.ncatalog.fo.featuresotherperformance	
C	33.50 kN
C0	19.20 kN
T min.	-4 °C
T max.	212 °C

Other features	
Weight	2.47 oz
Recommended tightening torque for set screw	8 Nm