

PDF technical sheet UC30618G2



Insert bearings

zinc-coated insert, spherical outer diameter with locking pin, fixing by socket set screw, seal with slinger, food grease

Product definition	
B	1.6929 "
C	0.9449 "
C1	0.2559 "
d	1.1250 "
D	2.8346 "
G	1/428UNF
m	0.2362 "
r	1.5
S	0.6693 "
SW	0.1250 "

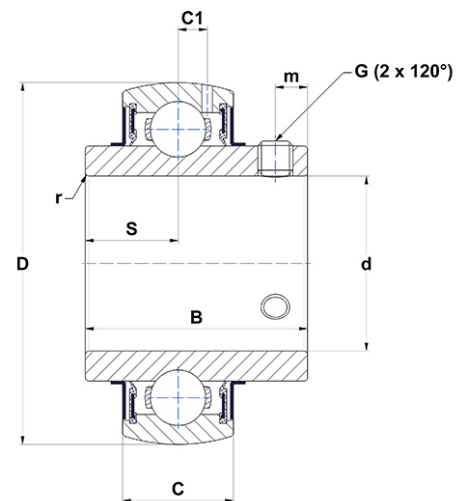

m.ncatalog.fo.featuresotherperformance	
C	27 kN
C0	15.20 kN
T min.	-4 °C
T max.	212 °C

Other features	
Weight	2.05 oz
Recommended tightening torque for set screw	3.70 Nm