

PDF technical sheet UC21444G2T20



Insert bearings

spherical outer diameter, fixing by socket set screw, labyrinth seal, for high-temp. applications

Product definition	
B	2.9370 "
C	1.1811 "
C1	0.3543 "
d	2.7500 "
D	4.9213 "
G	7/1620UNF
m	0.4724 "
r	2
S	1.1890 "
SW	0.2187 "

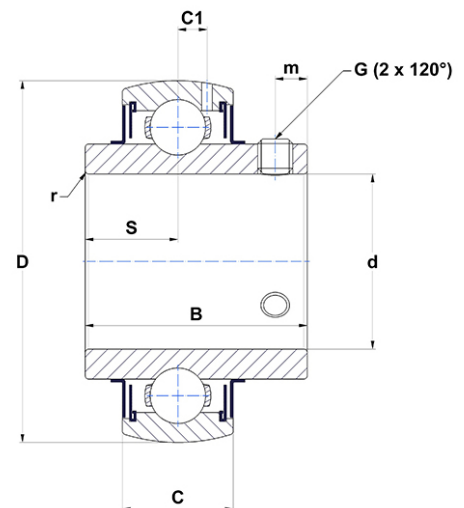

m.ncatalog.fo.featuresotherperformance	
C	62 kN
C0	45 kN
T min.	-4 °C
T max.	392 °C

Other features	
Weight	7.27 oz
Recommended tightening torque for set screw	27.10 Nm