

PDF technical sheet UC21239G2



Insert bearings

zinc-coated insert, spherical outer diameter with locking pin, fixing by socket set screw, seal with slinger, food grease

Product definition	
B	2.5630 "
C	1.0630 "
C1	0.3228 "
d	2.4375 "
D	4.3307 "
G	3/824UNF
m	0.4134 "
r	1.1
S	1.0000 "
SW	0.1875 "

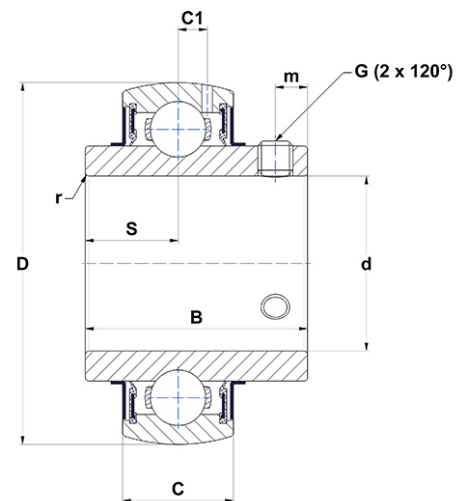

m.ncatalog.fo.featuresotherperformance	
C	52.50 kN
C0	32.80 kN
T min.	-4 °C
T max.	212 °C

Other features	
Weight	5.11 oz
Recommended tightening torque for set screw	16.80 Nm