

PDF technical sheet UC21135G2L3

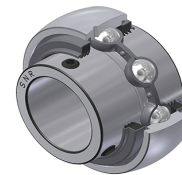

Insert bearings

spherical outer diameter, fixing by socket set screw, triple lip seal

Product definition	
B	2.1890 "
C	0.9843 "
C1	0.2835 "
d	2.1875 "
D	3.9370 "
G	3/824UNF
m	0.3543 "
r	1.1
S	0.8740 "
SW	0.1875 "

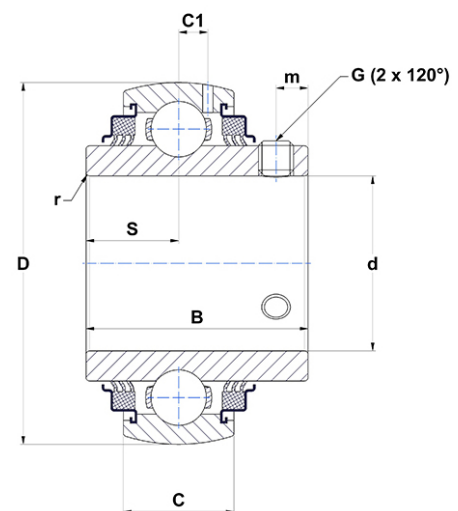

m.ncatalog.fo.featuresotherperformance	
C	43.55 kN
C0	29.20 kN
T min.	-4 °C
T max.	212 °C

Other features	
Weight	3.88 oz
Recommended tightening torque for set screw	16.80 Nm