

PDF technical sheet UC21030G2L3



Insert bearings

spherical outer diameter, fixing by socket set screw, triple lip seal

Product definition	
B	2.0315 "
C	0.9055 "
C1	0.2559 "
d	1.8750 "
D	3.5433 "
G	3/824UNF
m	0.3543 "
r	1.1
S	0.7480 "
SW	0.1875 "

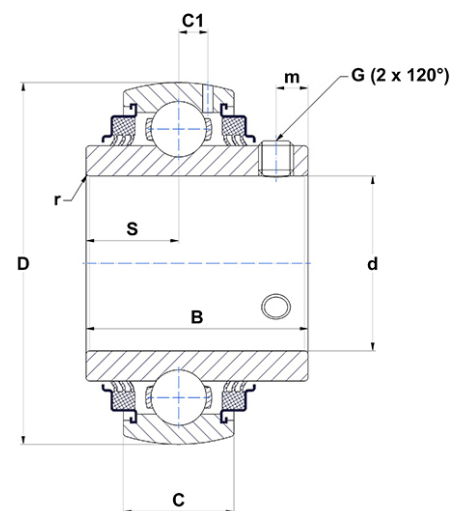

m.ncatalog.fo.featuresotherperformance	
C	35.10 kN
C0	23.20 kN
T min.	-4 °C
T max.	212 °C

Other features	
Weight	3.07 oz
Recommended tightening torque for set screw	16.80 Nm