

## PDF technical sheet UC20927G2L3

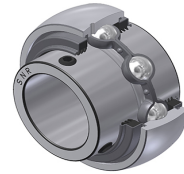

### Insert bearings

spherical outer diameter, fixing by socket set screw, triple lip seal

Product definition	
B	1.9370 "
C	0.8661 "
C1	0.2677 "
d	1.6875 "
D	3.3465 "
G	5/1624UNF
m	0.3150 "
r	1.1
S	0.7480 "
SW	0.1563 "

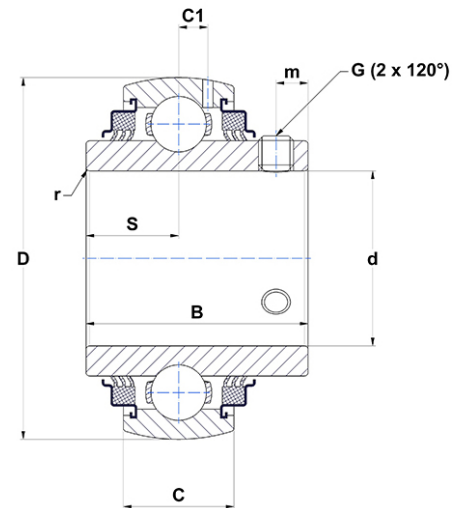

m.ncatalog.fo.featuresotherperformance	
C	31.85 kN
C0	20.80 kN
T min.	-4 °C
T max.	212 °C

Other features	
Weight	2.61 oz
Recommended tightening torque for set screw	8 Nm