

PDF technical sheet UC20620G2T20



Insert bearings

spherical outer diameter, fixing by socket set screw, labyrinth seal, for high-temp. applications

Product definition	
B	1.5000 "
C	0.7480 "
C1	0.1969 "
d	1.2500 "
D	2.4409 "
G	1/428UNF
m	0.2165 "
r	0.6
S	0.6260 "
SW	0.1250 "

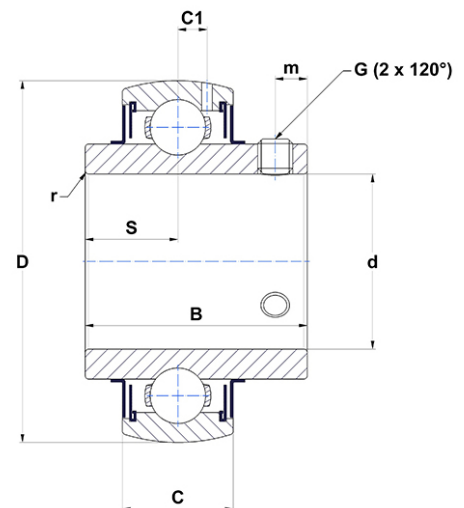

m.ncatalog.fo.featuresotherperformance	
C	19.50 kN
C0	11.20 kN
T min.	-4 °C
T max.	392 °C

Other features	
Weight	1.06 oz
Recommended tightening torque for set screw	3.70 Nm