

PDF technical sheet UC204G2L3



Insert bearings

spherical outer diameter, fixing by socket set screw, triple lip seal

Product definition	
B	1.2205 "
C	0.6299 "
C1	0.1732 "
d	0.7874 "
D	1.8504 "
G	M6x1
m	0.1850 "
r	0.6
S	0.5000 "
SW	0.1181 "

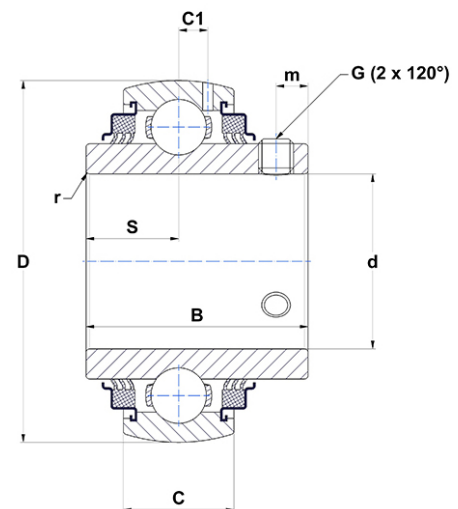

m.ncatalog.fo.featuresotherperformance	
C	12.80 kN
C0	6.65 kN
T min.	-4 °C
T max.	212 °C

Other features	
Weight	0.60 oz
Recommended tightening torque for set screw	5.50 Nm