

PDF technical sheet EX311G2L3

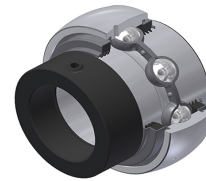

Insert bearings

spherical outer diameter, fixing by eccentric locking collar, triple lip seal

Product definition	
B	2.1890 "
B1	2.8740 "
B2	0.8740 "
C	1.3386 "
C1	0.4173 "
d	2.1654 "
d1	3.2677 "
D	4.7244 "
G	M10x1,25
m	0.3543 "
r	2
S	1.0945 "
SW	0.1969 "

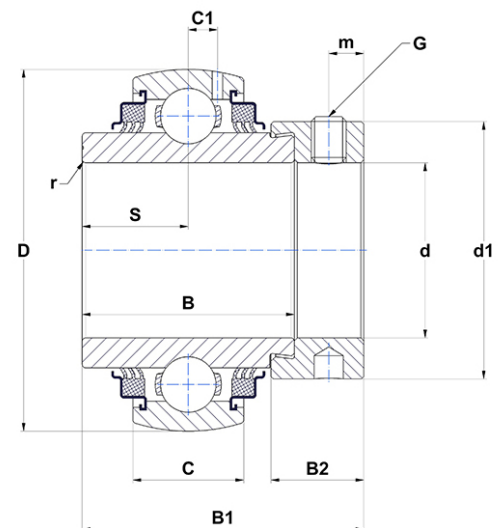

m.ncatalog.fo.featuresotherperformance	
C	71.50 kN
C0	44.80 kN
T min.	-4 °C
T max.	212 °C

Other features	
Weight	8.11 oz
Recommended tightening torque for set screw	22 Nm