

## PDF technical sheet EX30928G2

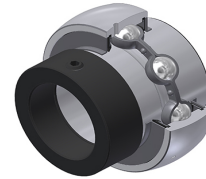

### Insert bearings

spherical outer diameter, fixing by eccentric locking collar, seal with slinger, for low-temp. applications

Product definition	
B	1.6890 "
B1	2.3110 "
B2	0.8110 "
C	1.1811 "
C1	0.3543 "
d	1.7500 "
d1	2.7559 "
D	3.9370 "
G	3/824UNF
m	0.3150 "
r	2
S	0.7795 "
SW	0.1875 "

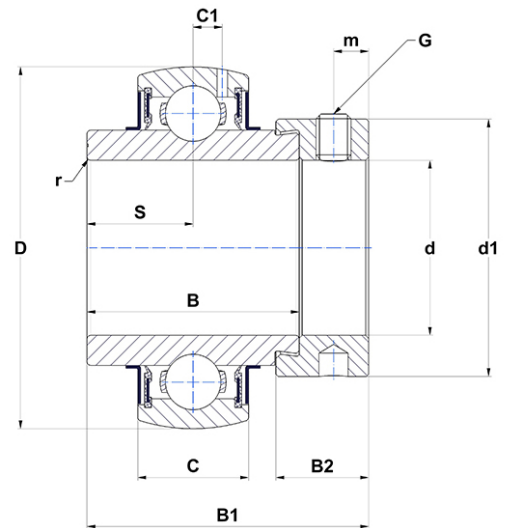

m.ncatalog.fo.featuresotherperformance	
C	53 kN
C0	31.80 kN
T min.	-4 °C
T max.	212 °C

Other features	
Weight	5.19 oz
Recommended tightening torque for set screw	16.80 Nm