

PDF technical sheet EX30515G2

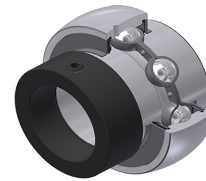

Insert bearings

spherical outer diameter, fixing by eccentric locking collar, seal with slinger, for low-temp. applications

Product definition	
B	1.3740 "
B1	1.8425 "
B2	0.6260 "
C	0.8268 "
C1	0.2441 "
d	0.9375 "
d1	1.6850 "
D	2.4409 "
G	5/1624UNF
m	0.2362 "
r	1.5
S	0.6575 "
SW	0.1563 "

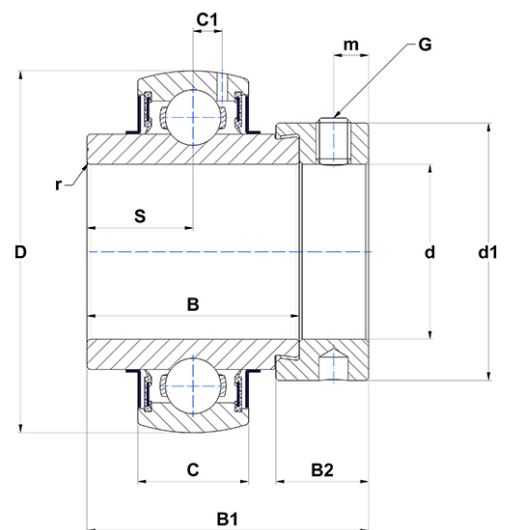

m.ncatalog.fo.featuresotherperformance	
C	22.36 kN
C0	11.50 kN
T min.	-4 °C
T max.	212 °C

Other features	
Weight	1.52 oz
Recommended tightening torque for set screw	8 Nm