

PDF technical sheet EX21444G2

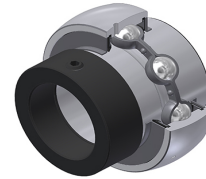

Insert bearings

spherical outer diameter, fixing by eccentric locking collar, seal with slinger, for low-temp. applications

Product definition	
B	2.6850 "
B1	3.3740 "
B2	0.9252 "
C	1.1811 "
C1	0.3543 "
d	2.7500 "
d1	3.8110 "
D	4.9213 "
G	3/824UNF
m	0.3346 "
r	2
S	1.3425 "
SW	0.1875 "

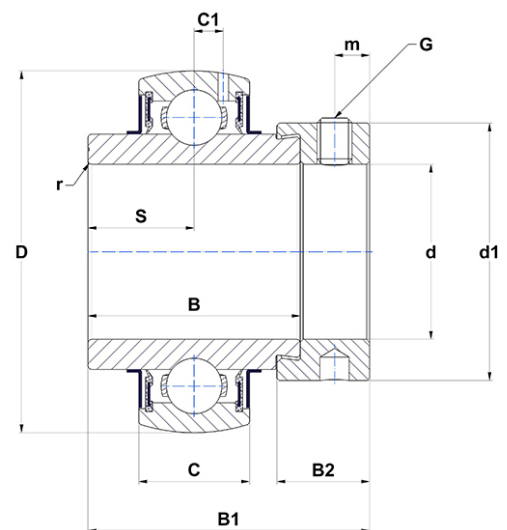

m.ncatalog.fo.featuresotherperformance	
C	62 kN
C0	45 kN
T min.	-4 °C
T max.	212 °C

Other features	
Weight	9.10 oz
Recommended tightening torque for set screw	16.80 Nm