

PDF technical sheet EX21238G2L3

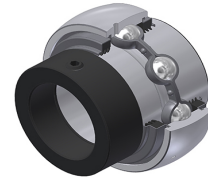

Insert bearings

spherical outer diameter, fixing by eccentric locking collar, triple lip seal

Product definition	
B	2.4331 "
B1	3.0591 "
B2	0.8780 "
C	1.0630 "
C1	0.3228 "
d	2.3750 "
d1	3.2283 "
D	4.3307 "
G	3/824UNF
m	0.3150 "
r	1.5
S	1.2165 "
SW	0.1875 "

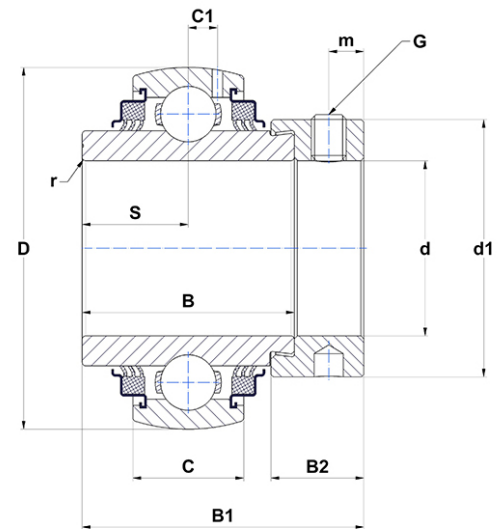

m.ncatalog.fo.featuresotherperformance	
C	52.50 kN
C0	32.80 kN
T min.	-4 °C
T max.	212 °C

Other features	
Weight	6.35 oz
Recommended tightening torque for set screw	16.80 Nm